

SciCan  
**STATCLAVE™ G4** - Chamber Autoclave

OPERATOR'S MANUAL

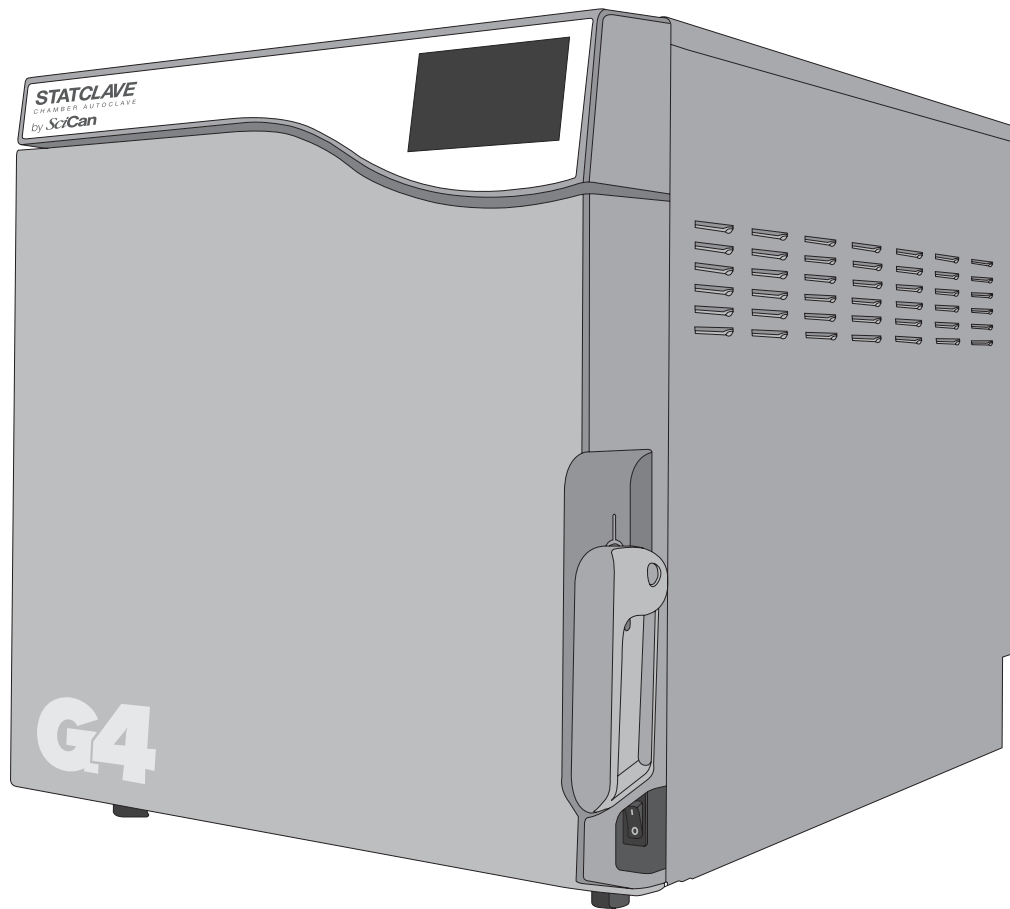

# Quick Start Guide

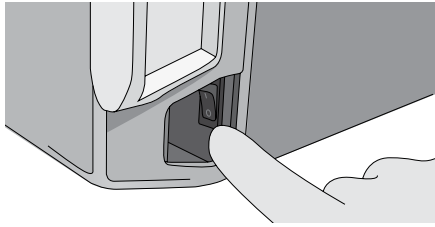

1. Switch the autoclave ON.

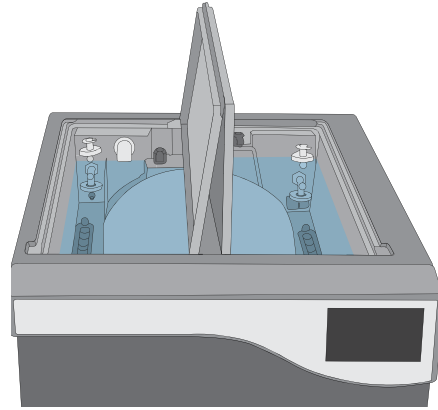

2. Ensure **BOTH** reservoirs are filled with high quality distilled water.

More information IN SECTION 4.

**IMPORTANT! Never Use Tap Water.**

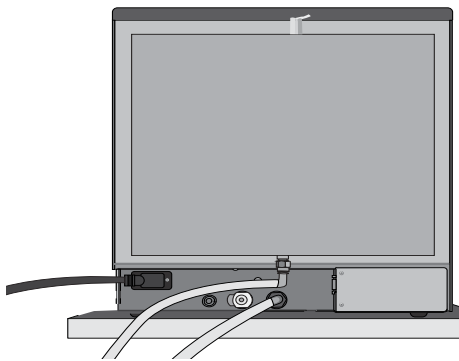

3. Ensure **BOTH** drainage tubes are connected at the back.

More information IN SECTION 2.3

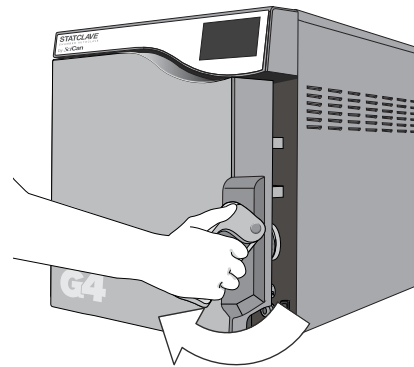

4. Pull up on the door latch to open the door.

More information IN SECTION 1.7

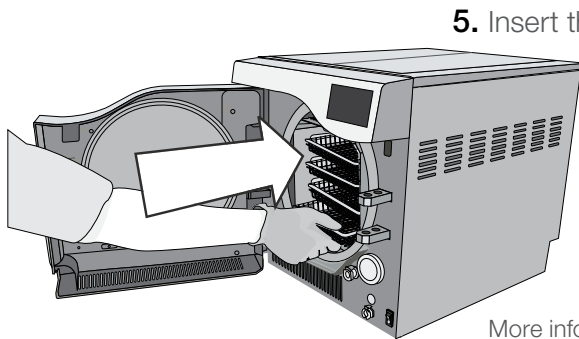

5. Insert the load.

More information IN SECTION 5.

**CAUTION: Hot Chamber**

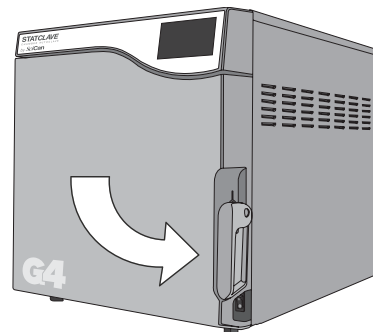

6. Close and latch the door.

You will hear the vacuum system activate. This is a normal operating sound.



7. Select a cycle.

More information IN SECTION 7.

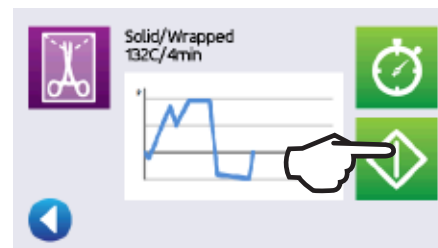

8. Press the **START** icon.

<b>1. Your STATCLAVE</b>	<b>3</b>	<b>9. Storing, Retrieving and Printing Sterilization Records</b>	<b>43</b>
1.1 Checking the Package Contents	3	9.1 Retrieving Cycle Information Using the Touchscreen	43
1.2 Important Information About Using Your STATCLAVE	4	9.2 Retrieving Cycle Information Using the Web Portal	43
1.3 Operating Principles, Key Features and Safety Devices	6	9.3 Retrieving Cycle Information Using the USB Data Back Up	43
1.4 Unit Overview	8	9.4 Connecting to a Printer	44
1.5 Touchscreen Overview	9	9.5 Adjusting your Print Settings	44
1.6 Using the Operation Screens	9	9.6 External Printer Specifications	45
1.7 Unlocking the Door	10		
<b>2. Set Up</b>	<b>11</b>	<b>10. Maintenance Procedures</b>	<b>46</b>
2.1 Installing Your STATCLAVE	11	10.1 Preventative Maintenance Message	46
2.2 Connecting and Powering Your STATCLAVE	12	10.2 Preventative Maintenance Schedule	46
2.3 Connecting Your STATCLAVE's Water Draining System	12	10.3 Cleaning the Door Seal and Door Plate	47
2.4 Connecting your STATCLAVE to a Network	14	10.4 Cleaning the Sterilization Chamber, Rack and Trays	47
<b>3. Getting Started</b>	<b>16</b>	10.5 Cleaning and Disinfecting the External Surfaces	47
<b>4. Filling the Water Reservoirs</b>	<b>17</b>	10.6 Draining the Reservoirs for Cleaning	48
4.1 Manual Filling Using Reservoir Top	19	10.7 Cleaning the Water Reservoirs and Reservoir Filters	48
4.2 Manual Filling Using Quick Connector at Unit Front	20	10.8 Cleaning the External Distilled Water Tank	49
4.3 Automatic Filling Using a Vista Pure Specialized Water Filtration System with Accumulation Tank	21	10.9 Cleaning the Chamber Filters	49
4.4 Automatic Filling Using External Water Tank and Auxiliary Pump	22	10.10 Replacing the Bacteriological Filter	50
<b>5. Loading Instruments</b>	<b>23</b>	10.11 Replacing the Door Seal	50
5.1 Using the Chamber Rack	24	10.12 Using on-Screen Instructions	51
5.2 Wrapped Instruments	25	10.13 Enabling a Technician to Access Your STATCLAVE from a Remote Location	51
5.3 Unwrapped Instruments	27	10.14 Preparing the Unit for Shipping	52
5.4 Rubber and Plastics	28	<b>11. Troubleshooting</b>	<b>53</b>
5.5 Textiles and Surgical Packs	28	<b>12. Ordering Spare Parts and Accessories</b>	<b>57</b>
5.6 Using Biological and Chemical Indicators	28	<b>13. Warranty</b>	<b>58</b>
<b>6. Using Your STATCLAVE</b>	<b>29</b>	Limited Warranty	58
6.1 Running a Cycle	29	<b>14. Specifications</b>	<b>59</b>
6.2 Stopping a Cycle	31	<b>APPENDIX A</b>	<b>60</b>
6.3 Using the Start Delay	32	Software Icons	60
6.4 Emergency Door Opening	33	<b>APPENDIX B</b>	<b>61</b>
6.5 Running a Vacuum Test	34	Software Screens	61
6.6 Running a Bowie-Dick Test	35	<b>APPENDIX C</b>	<b>62</b>
<b>7. Sterilization Cycles</b>	<b>36</b>	STATCLAVE Cybersecurity Statement	62
<b>8. Using and Changing Settings</b>	<b>37</b>		
8.1 Setting Up Load Traceability with User ID, PIN and Process Enforced Usage	39		
8.2 Setting Drying Time	41		
8.3 Setting the Stand-By Mode	41		
8.4 Setting Up and Using Your STATCLAVE Web Portal	41		
8.5 Registering for STATCLAVE Online Access	42		

# 1. Your STATCLAVE

## 1.1 Checking the Package Contents

When you receive your STATCLAVE™, the items listed below will be included. If any of the items are missing, contact your dealer immediately.

### Included with Your STATCLAVE

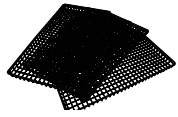

4 Stainless steel wire instrument trays



1 Wastewater bottle



1 Chamber rack



1 Memory stick



Operator's manual

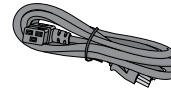

Power cord

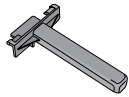

1 Tray extractor with door unlocking pin

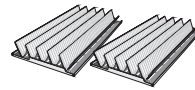

2 Pouched instrument racks



2 Long silicone tubes with elbow connectors

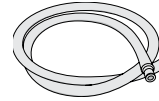

1 Reservoir drain tube (for use when cleaning reservoirs)



3 Drying plates



Direct-to-drain hardware

### The following terms appear in this manual:

**CAUTION!** A potential hazard to the operator or end patient

**IMPORTANT!** A situation that may affect the functioning of the unit.

**TIP** Additional information that may be helpful.

## 1.2 Important Information About Using Your STATCLAVE

### Intended Use

The STATCLAVE G4 is a dynamic-air-removal (pre-vacuum) table-top steam sterilizer intended for use by a health care provider to sterilize medical products by means of pressurized steam.

It is suitable for the sterilization of dental and medical instruments that are validated to be sterilized by steam. The STATCLAVE G4 has not been designed to sterilize liquid loads, bio-medical waste or materials not compatible with steam sterilization. The processing of such loads may result in incomplete sterilization and / or damage to the autoclave.

Please refer to the table below for program description, cycle times, temperature and dry times.

Program	Load Description	Sterilization Temperature / Exposure Time	Drying Time	Maximum Load
<b>Solid/Unwrapped</b>	IUSS CYCLE* for unwrapped solid instruments (mirrors, explorers), hinged instruments (hemostats) on trays.	132°C /270°F for 4 minutes	Not applicable	6 kg /13.2 lbs
<b>Solid/Wrapped</b>	Wrapped IMS cassettes with solid instruments, rigid sterilization containers with solid instruments or single pouched solid instruments on a pouch rack.	132°C /270°F for 4 minutes	25 minutes (up to 6 kg /13.2 lbs of load) 15 minutes (up to 1.4 kg / 3 lbs of load**)	6 kg /13.2 lbs
<b>Hollow/Unwrapped</b>	IUSS CYCLE* for unwrapped dental handpieces on trays.	132°C /270°F for 4 minutes	Not applicable	6 kg /13.2 lbs
<b>Hollow/Wrapped</b>	Single-pouched dental handpieces on a pouch rack.	132°C /270°F for 4 minutes	25 minutes (up to 6 kg /13.2 lbs of load) 15 minutes (up to 1.4 kg / 3 lbs of load)	6 kg /13.2 lbs
<b>Textiles/Porous Wrapped</b>	Textiles	32°C /270°F for 4 minutes	20 minutes	2 kg /4.4 lbs
<b>Rubber &amp; Plastic</b>	IUSS CYCLE* for unwrapped solid or hollow instrument.	121 °C /250°F for 20 minutes	Not applicable	2 kg /4.4 lbs

\*Immediate Use Steam Sterilization cycle.

\*\*For optimal drying of these loads, SciCan recommends using only one pouch rack loaded on the second from top rail.

## **Get to Know Your STATCLAVE: Read this Manual**

The details of installing, using and maintaining your STATCLAVE are all in this manual. Please read this manual before operating the unit and keep it for future reference. Users should follow the operating instructions and maintenance schedule described in this manual. Contents of this manual are subject to change without notice to reflect changes and improvements to the STATCLAVE product.

For more information about instrument suitability for steam sterilization, consult the instrument manufacturers' reprocessing instructions.

### **Water Quality**

High quality distilled water is recommended for use in your STATCLAVE. Deionized, demineralized, or specially filtered water can also be used. Never use tap water.

### **User Qualifications**

The operation of this unit should be restricted to trained and authorized personnel.

### **Repair and Modifications**

Do not permit any person other than certified personnel to supply parts, service or maintain your STATCLAVE. SciCan shall not be liable for incidental, special or consequential damages caused by any maintenance or services performed on the STATCLAVE by a third party, or for the use of equipment or parts manufactured by a third party, including lost profits, any commercial loss, economic loss, or loss arising from personal injury.









Never remove unit panels. Never insert objects through holes or openings in the cabinetry (unless explicitly instructed as in the emergency door opening procedure, for example). Doing so may damage the unit and / or pose a hazard to the operator.

### **WiFi Compliance**

This device has been tested and found to comply with the limits for a Class B digital device pursuant to the Federal Communications Commission's Part 15 Subpart B. The total radiated energy from the Main antenna connected to the Wireless Card conforms to the FCC limit of the SAR (Specific Absorption Rate) requirement regarding 47 CFR Part 2 Section 1093, when the sterilizer was tested. The transmission antenna for the wireless card is located in the front fascia.

**CAUTION! Follow your local guidelines governing verification of the sterilization procedure.**

**Pay close attention to the following symbols that appear on the unit:**

	<b>Caution:</b> A potential hazard to the operator		Venturi reservoir drain
	<b>Caution:</b> Hot surface		Clean water drain
	<b>Caution:</b> Danger of electric shock. Disconnect power supply when servicing unit.		Condenser drain (only used for shipping and servicing)
	Clean water fill		Exhaust drain

### 1.3 Operating Principles, Key Features and Safety Devices

The STATCLAVE is a chamber autoclave that uses steam to sterilize wrapped and unwrapped instrument loads typically used in dental and medical offices. It has six sterilization cycles and each finishes with optimized drying for fast, effective instrument processing.

#### How it Works

The STATCLAVE uses a pre- and post-vacuum to condition the load at the beginning and end of each cycle.

- › The pre-vacuum draw removes the air from the chamber before sterilization begins. This ensures more efficient steam penetration into every load.
- › The post-vacuum draw at the end of the cycle pulls the moist air from the chamber while heater bands warm the chamber walls to speed drying.
- › Finally, fresh, filtered air is drawn into the chamber to eliminate condensate and cool the chamber. This reduces the cooling time and ensures the load is dry the moment you open the door.

#### Why Connect It

The STATCLAVE's WiFi-enabled G4 technology records and monitors information on every cycle to protect your office and your patient. When your unit is connected to a network, it can automatically send error codes for off-site service technicians to troubleshoot a problem early on - before it costs your operation time and money. You can also access your STATCLAVE's information through a portal using your browser. Here you can view not only your unit's current operations in real time, but also access cycle history, printing and validation information and sterilization records dating back to the day your unit was manufactured.

## Other Features

### Closed-door drying

Ensures your wrapped and pouched loads finish dry and ready to store.

### Deep chamber

Holds up to 4 large and 4 small IMS cassettes or up to 20 pouched loads.

### Reservoir fill options

Includes front and top options, as well as an autofill port at the back.

### Chamber preheating

Programmable chamber preheating and unit Stand-by mode ensure the STATCLAVE is warm and ready when you need it.

### Delayed start option

Every sterilization cycle allows you to schedule cycles with your workflow or even start the day with a clean instrument load.

### Water quality sensor

Protects the unit from the long-term damage of unsuitable water.

### Motor-less door latching mechanism

Provides improved reliability over motorized door locks.

### Flip-top water reservoir

Makes the STATCLAVE easy to fill and clean.

### Read-at-a-glance, color touchscreen

Offers real-time monitoring of all the important sterilization parameters.

### Easy-to-use emergency door opening

Simple procedure to open the door and retrieve instruments in the event of a power loss.

### Programmable features

Automate your regular vacuum tests to be completed BEFORE the start of your work day.

### Low water indicator

Know when there is not enough water to run a full cycle - before you start it.

### Space-saving design

Front venting and recessed connections at the back allow the unit to fit snugly into compact steri-centers.

### Door monitoring system

Tells you if the door is properly closed.

## Safety Devices

### Overheat thermostat

Band heater safety thermostats and steam generator safety thermostat protect the unit.

### Pressure relief valve

Chamber pressure relief valve protects the unit and users.

### Pressure or vacuum relief on power failure

Automatic pressure or vacuum relief protects users when the power is interrupted.

### Electronics protection

Controller board fuses protect the unit's electronics.



## 1.4 Unit Overview

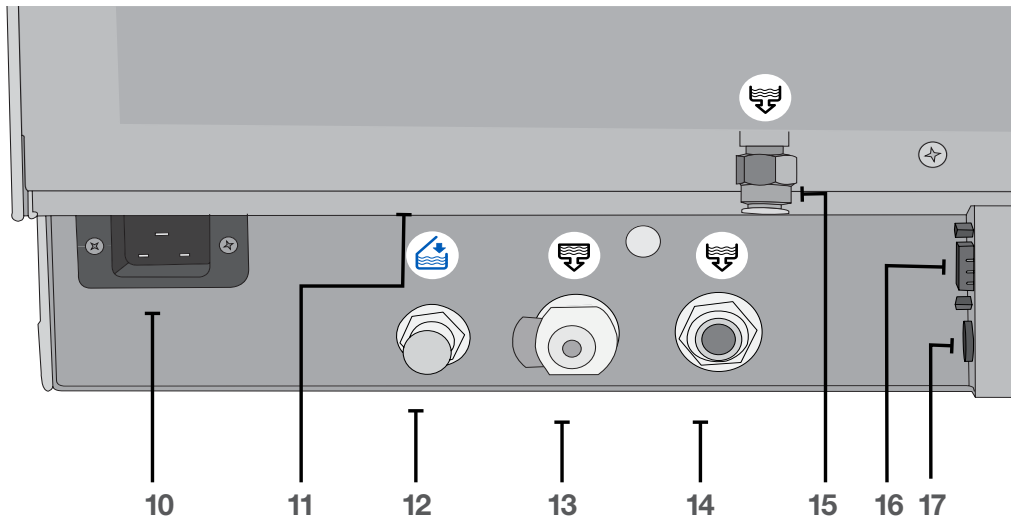
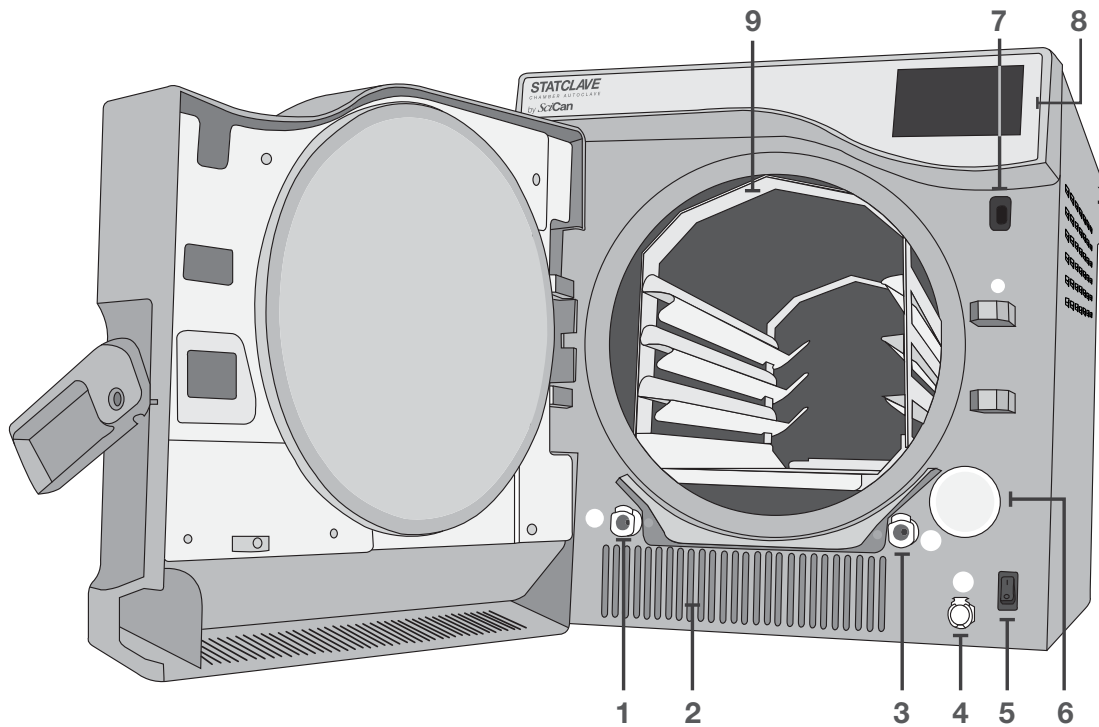

- |  |  |
|--|--|
| <b>1.</b> Wastewater reservoir drain quick-connect (OUT)         | <b>8.</b> Touchscreen                                    |
| <b>2.</b> Warm air exhaust                                       | <b>9.</b> Chamber rack                                   |
| <b>3.</b> Clean water reservoir drain quick-connect (OUT)        | <b>10.</b> Power cord input                              |
| <b>4.</b> Clean water reservoir fill quick-connect (IN)          | <b>11.</b> Ethernet port (not visible)                   |
| <b>5.</b> Power switch   | <b>12.</b> Automatic fill port for clean water reservoir |
| <b>6.</b> Bacteriological filter (bacteria-retentive air filter) | <b>13.</b> Condenser drain port (to drain for shipping)  |
| <b>7.</b> USB port   | <b>14.</b> Overflow drain port for reservoirs            |
|  | <b>15.</b> Exhaust drain port                            |
|  | <b>16.</b> RS232 port                                    |
|  | <b>17.</b> Power port for external fill pump (option)    |

# 1.5 Touchscreen Overview

## Home Screen

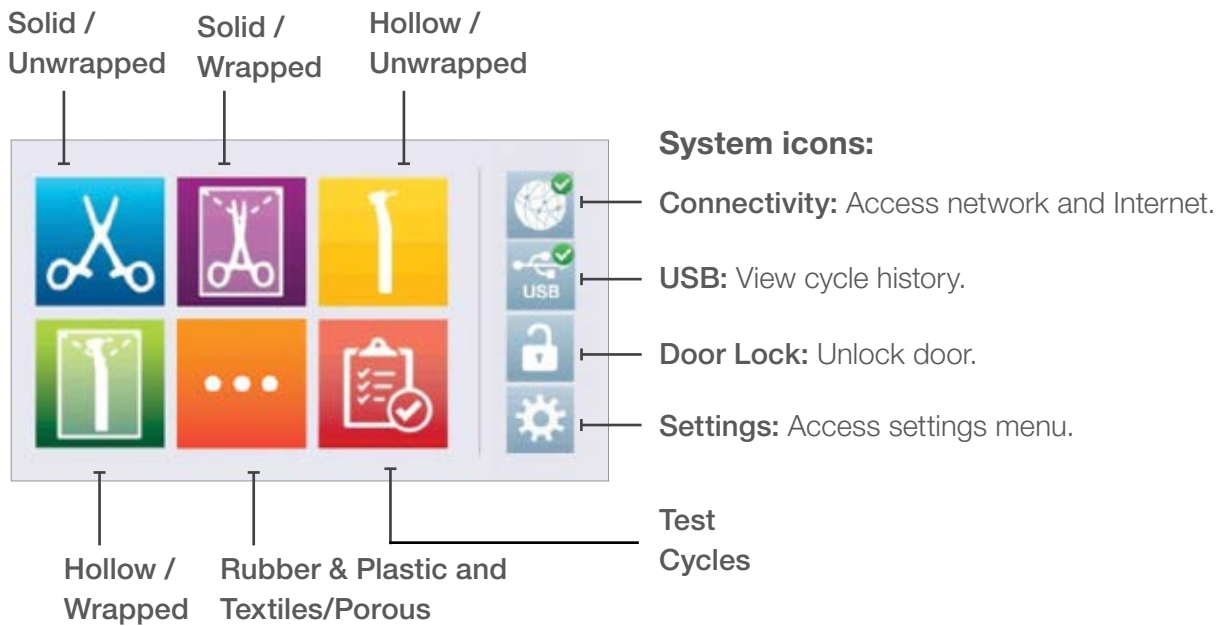

Complete cycle information in Section 7.

# 1.6 Using the Operation Screens

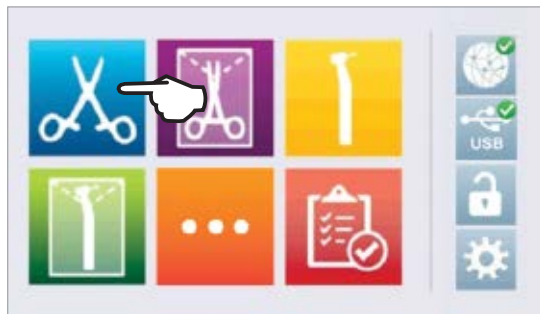

1. Select a cycle.

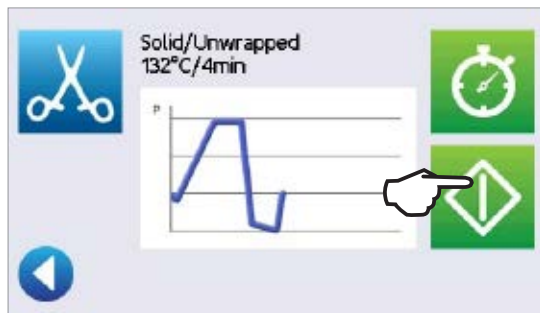

2. Press START.

Delayed start More information in Section 6.3

Start



3. Cycle in progress.

- Current chamber temperature
- Current chamber pressure
- Total time elapsed in the cycle - seen on cycle screen for entire cycle
- Appears during STERILIZATION and DRYING to show time remaining.
- Stop

## 1.7 Unlocking the Door

The STATCLAVE will lock the chamber door when you select a cycle. To unlock the door, go to the home screen and follow these steps.

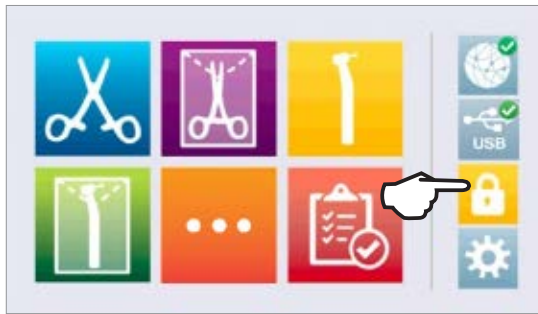

1. PRESS lock icon.



2. PRESS unlock.

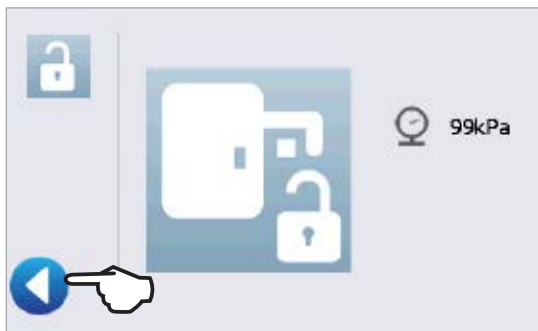

3. PRESS back.

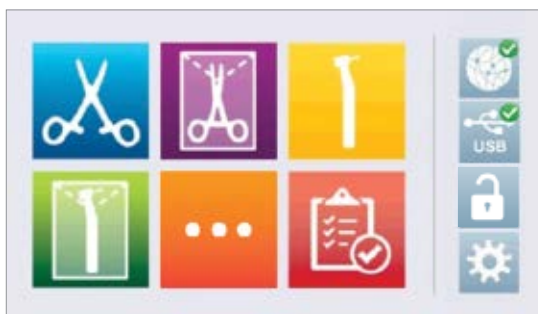

4. Lock icon now changed to unlocked.

## 2. Set Up

### 2.1 Installing Your STATCLAVE

- › Place the STATCLAVE on a flat level surface strong enough to support a 165 lbs (75kg) load.
- › Allow for at least 7" (180 mm) of space ABOVE the unit to enable access to the reservoirs. If there is less than 7" (180 mm) above the unit, use a screwdriver to remove the front hinge of the clean water reservoir so that it can slide in and out of position from the front of the unit.
- › On the right side of the unit, allow for at least 2" (50 mm) of space for ventilation.
- › The unit vents warm air from below the door. Ensure the door overhangs the level surface.

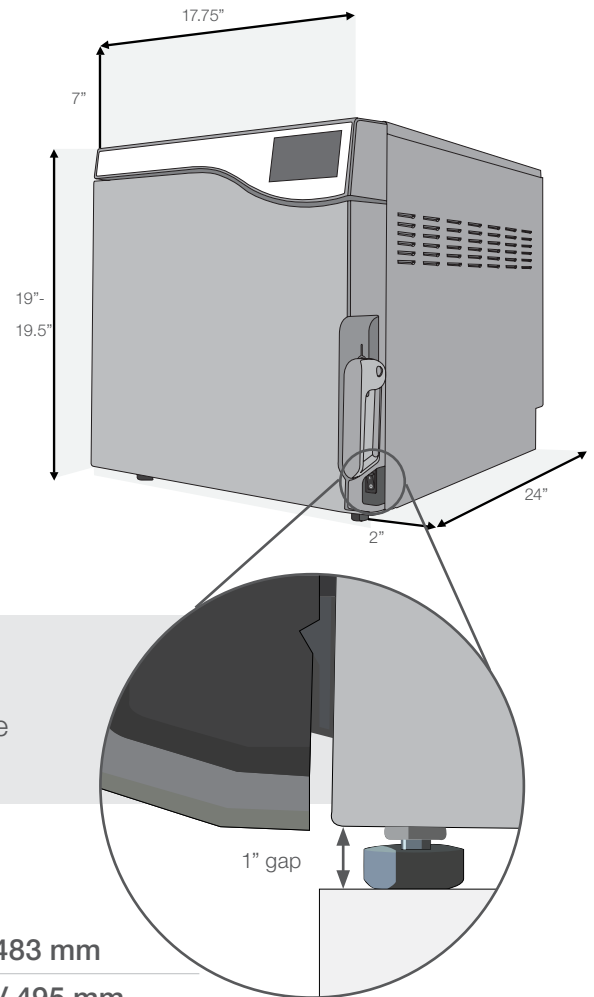

**IMPORTANT!** To improve drainage, ensure the unit is tilted toward the back. Use the leveling feet to ensure the front of the unit is 1" (25mm) from the level surface.

#### Unit Dimensions and Operating Environment

Height with front legs retracted	19" / 483 mm
Height with front legs fully extended	19.5" / 495 mm
Width	17.75" / 450 mm
Depth	25" / 635 mm
Weight (empty)	136 lbs/ 61.7kg
Weight (with full reservoirs and full load)	175 lbs/ 79.5kg

#### Temperature and Humidity

Avoid installing your STATCLAVE in direct sunlight or close to a heat source such as vents or radiators. The recommended operating temperatures are between 5-40°C / 41°F-104°F with humidity of maximum 80%.

#### Electromagnetic Environment

Your STATCLAVE has been tested and meets applicable standards for electromagnetic emissions. While your unit does not emit any radiation, it may itself be affected by other equipment that does. We recommend that your unit be kept away from potential sources of interference.

## 2.2 Connecting and Powering Your STATCLAVE

1. Ensure the power switch at the front right of the unit is in the OFF position and connect the power cord supplied to the power port at the back of the unit.

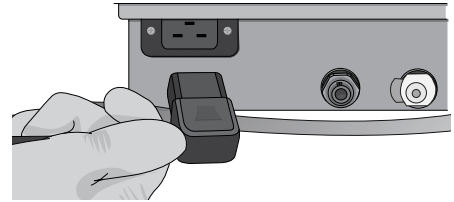

2. Connect directly to a power source. Don't use an extension cord.

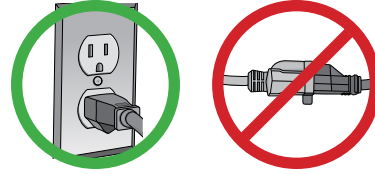

3. Turn ON the power switch located at the front right of the unit.

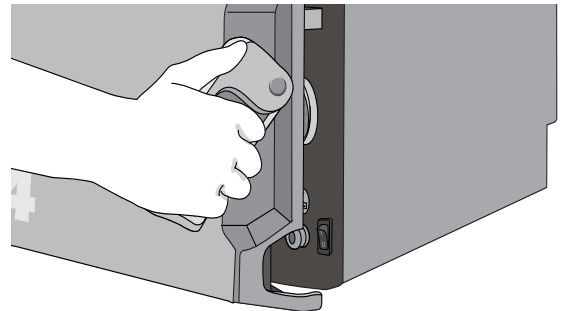

**IMPORTANT!** Keep the door open when powering the unit ON for the first time to allow the unit to accurately read the local atmospheric pressure. If the unit misreads the pressure, it may lock the door.

### Electrical Connections

To power your unit, use properly grounded and fused power sources with the same voltage rating as indicated on the label at the back of your STATCLAVE.

- › **DO** use an outlet that is protected by a 15A breaker.
- › **DO** use a dedicated circuit, single phase 120 V~ 60Hz, 12A.

### Unit Electrical Characteristics:

- › Protection class 1 device.
- › Maximum power consumption of the autoclave is 1,440 Watts for 120V.

## 2.3 Connecting Your STATCLAVE's Water Draining System

**IMPORTANT!** For the unit to function, BOTH reservoirs must be full and BOTH drain tubes must be connected.

The STATCLAVE uses water from the Venturi reservoir to generate vacuum draws at the beginning and end of each cycle. For the unit to operate, BOTH the clean water reservoir and the Venturi reservoir must contain the minimum required water levels.

When the chamber releases steam it travels through the condenser and drains from the condenser exhaust tube. Excess water in both the Venturi reservoir and the clean water reservoir drains from the reservoir overflow tube. BOTH elbow fittings at the back of the unit must be connected to a water draining system.

## Connecting Directly to a Drain

Any new central drain point installation should be done by a technician. The drain points (C) must be located on the upper portion of vertical drain pipe ABOVE the P-trap.

For direct-to-drain connections, you will need to use the **direct-to-drain hardware** (provided with the unit).

1. The unit is shipped with plugs in its ports. To remove a plug, apply even pressure to the **Inner Ring** holding it down on either side of the plug and pull out the plug.

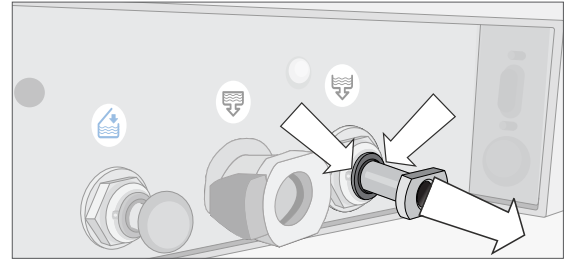

2. Insert one elbow connector with silicone tube to the metal exhaust port (A).

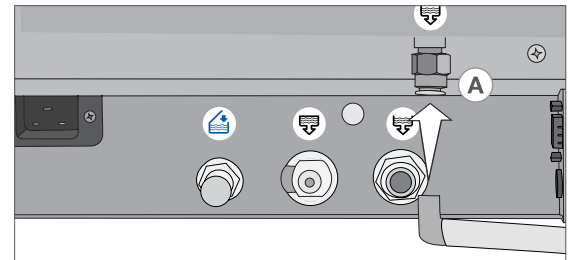

3. Insert the other elbow connector with silicone tube to the plastic reservoir overflow drain port (B).

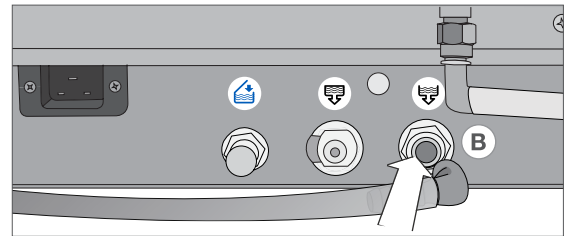

4. Connect the exhaust tube with elbow fittings (A) to the port installed on the drain pipe (C).
5. Connect the reservoir overflow tube (B) to the remaining port on the drain pipe (C).

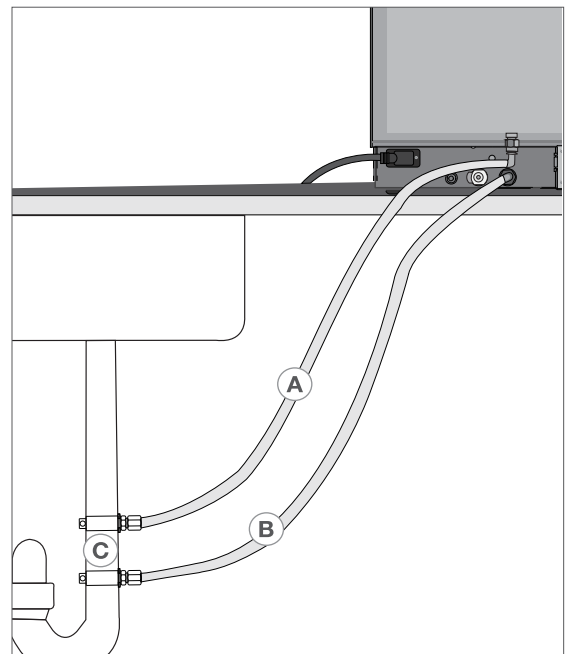

**IMPORTANT!** Avoid excess sagging in the lines; cut both tubes to measure.

### TIP

**Do you want to drain the unit prior to shipping or cleaning?** For instructions on how to completely drain both reservoirs for shipping or cleaning, see Section 10.6 Draining the Reservoirs for Cleaning and Shipping.

## Connecting the Waste Bottle

The unit is shipped with a waste bottle in case a direct-to-drain installation is not possible. To use the waste bottle, follow these steps:

1. Set the waste bottle (D) on the ground or in the cabinetry below the unit.
2. Connect the exhaust tube (A) to a port on the waste bottle cap (C).
3. Connect the reservoir overflow tube (B) to a port on the waste bottle cap (C).

**IMPORTANT!** Avoid excess sagging in the lines; cut both tubes to measure.

**IMPORTANT!** Tubes should not be kinked, bent or otherwise obstructed. The connection point to the central drain must be lower than the autoclave's support surface otherwise the reservoirs may not drain correctly.

**TIP** Add a small amount of water to the empty waste bottle to give it stability.

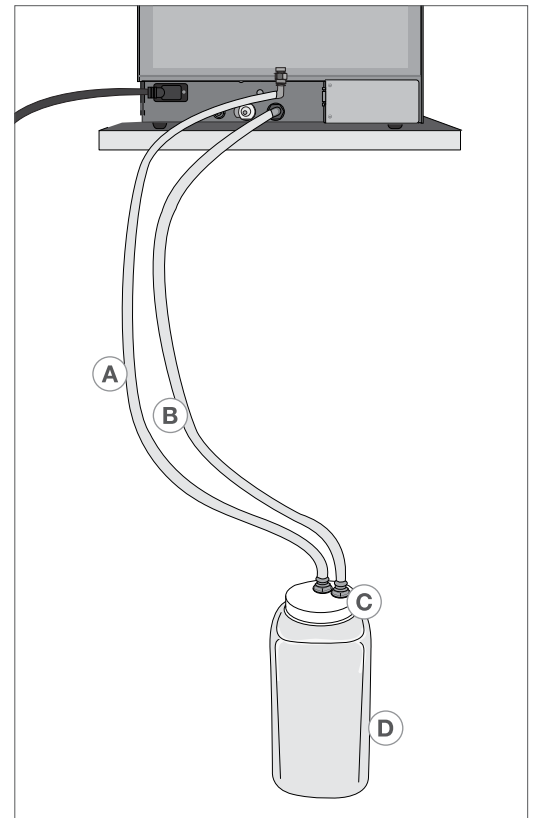





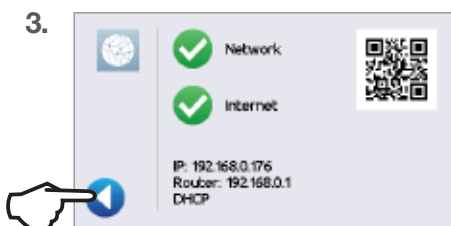
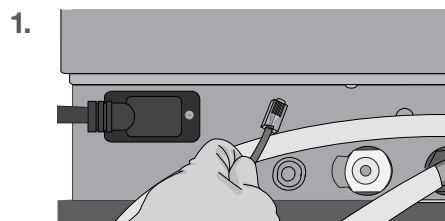

## 2.4 Connecting your STATCLAVE to a Network

### Connecting to a Wired Network

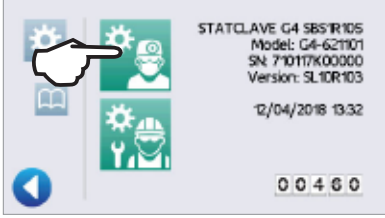

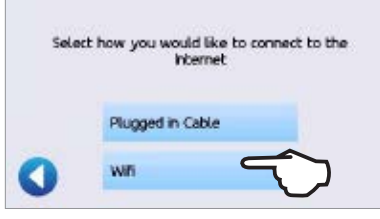
## Connecting to a Wireless Network

From the unit's home screen, select , then follow these steps:

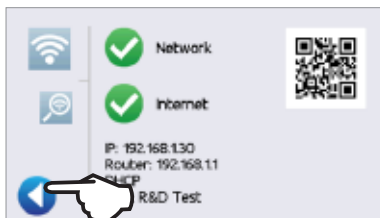
- 1. The home screen displays system information: STATCLAVE G4 SBS R105, Model: G4-62101, SN: 710117K00000, Version: SL10R103, and the date/time 12/04/2018 13:32. A hand icon points to the settings gear icon in the top left.
- 2. The Setup menu is shown with options: Network Setup, Sound, and Instructions. A hand icon points to Network Setup.
- 3. The Network Setup menu is shown with options: Network, Automatic IP (DHCP), and Renew IP. A hand icon points to Network.
- 4. The screen asks to select how to connect to the Internet, with options: Plugged in Cable and Wifi. A hand icon points to Wifi.
- 5. The Select Wireless network screen shows three networks: R&D Test, Statim G4, and 100. A hand icon points to R&D Test.
- 6. The Enter password screen shows a virtual keyboard. A hand icon points to the right arrow key.
- 7. A blue box displays the text: Please wait, connecting to Internet.
- 8. The screen shows successful connection for Network and Internet, with a QR code and IP address information: IP: 192.168.130, Router: 192.168.11. A hand icon points to the R&D Test network name.

### TIP

#### Data Security and WiFi

Ensuring your WiFi® connections are secure is an important element of safeguarding your organization's data. A WiFi network using WPA2™ provides both security (you can control who connects to it) and privacy (the transmissions cannot be read by others) for communications as they travel across your network. For maximum security, your network should include only devices with the latest in security technology – WiFi Protected Access® 2 (WPA2).

#### Tips for securing your network

Change the Web Portal password from the default value and update it on a regular basis as per user's office IT policy. See the web Portal Help tab for instructions on changing your password.

Change the network name (SSID) from the default name.

Change the administrative credentials (username and password) that control the configuration settings of your Access Point/Router/Gateway.

Enable WPA2-Personal (aka WPA2-PSK) with AES encryption.

#### Wireless transmission considerations

To comply with Federal Communications Commission and Industry Canada Radiofrequency exposure compliance requirements, the antenna used for this transmitter must be installed to provide a separation distance of at least 20 cm from all persons and must not be co-located or operating in conjunction with any other antenna or transmitter.

For STATCLAVE's Cybersecurity Statement, see Appendix C



### 3. Getting Started

#### Preparing Your STATCLAVE for Use

Once the STATCLAVE has been correctly installed, and before using it for the first time, make sure BOTH the clean water and Venturi reservoirs contain distilled water. The STATCLAVE uses the Venturi system to generate vacuum draws at the beginning and end of each cycle. Both reservoirs must contain the minimum required water levels for the unit to function.

**IMPORTANT!** DON'T run the STATCLAVE without the chamber rack in place.

1. Power on the unit.

**IMPORTANT!** Keep the door open when powering the unit ON for the first time to allow the unit to accurately read the local atmospheric pressure. If the unit misreads the pressure, it may lock the door.

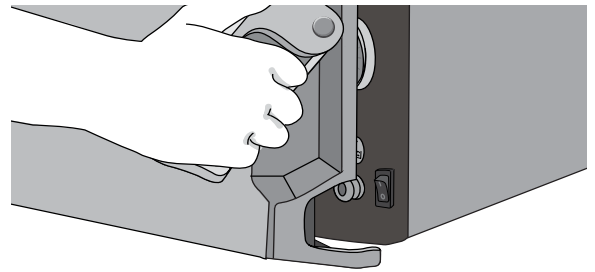

2. Follow the screen prompts to connect your STATCLAVE using either WiFi or an Ethernet cable connection. This will automatically set the time and date for your unit.



**TIP**

If you do not wish to connect your STATCLAVE at this time, Press and select a language. Then press and to scroll to the end of the introduction. You must Agree or Disagree with the Privacy Policy to get to the home screen. (For more information on the Privacy Policy screen see Section 8. Using and Changing Settings)

From the home screen, select then and then select the **GENERAL** button to access the menu for time, date, country, and time zone. (See Section 8. Using and Changing Settings)

SciCan recommends connecting and registering your STATCLAVE. To do this at a later time, See Section 8.5 Registering for STATCLAVE Online Access.

3. Open the CLEAN WATER RESERVOIR located on the top right of the unit. Using a large container, fill with distilled water to the maximum fill level line or until you hear 3 BEEPS.  
(For more fill options see Section 4. Filling the Water Reservoirs.)

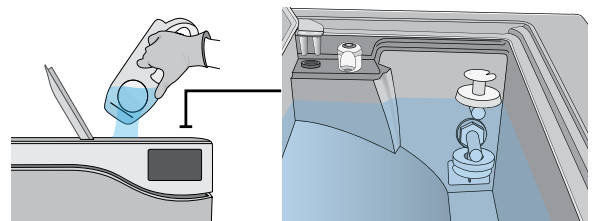

4. Open and fill the WASTEWATER RESERVOIR to the maximum fill level.

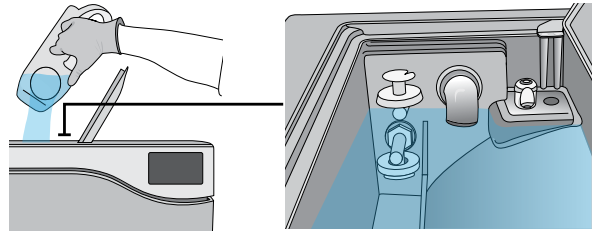

5. Open the door, plug the USB storage device into the USB port, and make sure the bacteriological filter is secured in place.

**CAUTION! Hot Chamber.**  
The unit's Stand-by mode is preset to maintain a hot chamber.

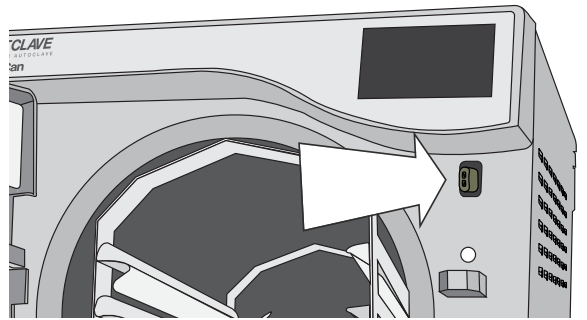

6. Check your national and local guidelines for any additional protocols and tests required before using your unit.

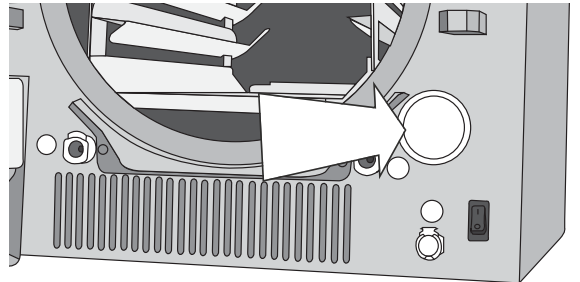

## 4. Filling the Water Reservoirs

Normal operation of the STATCLAVE requires a minimum amount of distilled water in BOTH the clean water reservoir and Venturi reservoir.

To fill the Venturi reservoir:

1. Open the Venturi reservoir lid located on the top left of the unit.

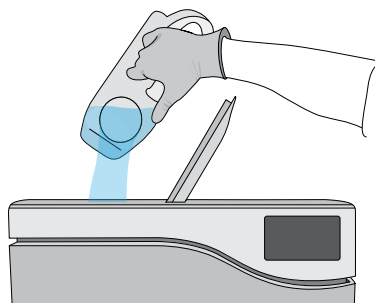

2. Fill it with distilled water to the maximum fill line indicated in the reservoir.

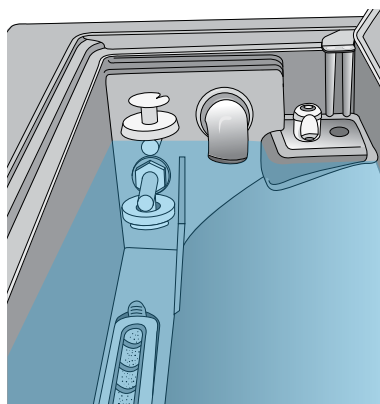

**TIP** When filling the Venturi reservoir for the first time, you will need to add an additional 0.5 US gal / 2 L of water. This will fill the steam cooling system's condenser. To do this, simply fill the Venturi reservoir to the maximum fill line and wait as the Venturi reservoir water fills the condenser, then top up the Venturi reservoir to the maximum fill line again.



### Setting the water reservoir filling mode

Your STATCLAVE's default filling option is MANUAL. If you are manually filling the reservoir, you do not need to change the unit's fill option settings.

If you are connecting your STATCLAVE to an external filling device such as a Vista Pure water purification system or external water tank and auxiliary pump, make sure your unit is set to the AUTOMATIC filling mode.

To change this setting from the home screen, select  then  and then follow these steps:



To fill the clean water reservoir, there are four different methods:

- › Manual filling using **RESERVOIR TOP**.
- › Manual filling using the **FRONT QUICK CONNECTOR**.
- › Automatic filling using **VISTA PURE SPECIALIZED WATER FILTRATION SYSTEM** with accumulation tank.
- › Automatic filling using an **EXTERNAL WATER TANK AND AUXILIARY PUMP**.

## 4.1 Manual Filling Using Reservoir Top

1. With the unit powered ON, flip open the clean water reservoir lid located on the top right of the unit.

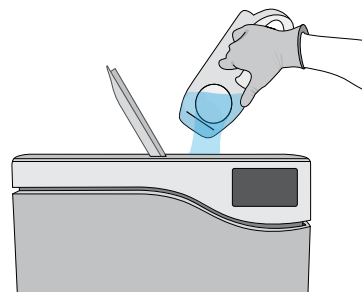

2. Using a large container, fill with distilled water to the maximum fill line or until you hear 3 BEEPs.

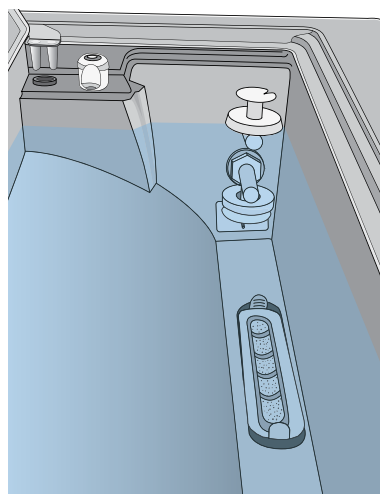

3. With the door open, access the LCD home screen and select any cycle to view the pre-cycle information screen.

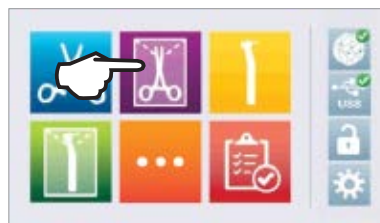

4. The clean water level check mark will turn yellow when the minimum water level is reached and green when the reservoir is filled to the maximum level.

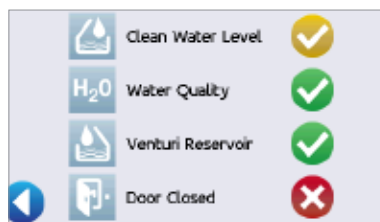

**TIP** You can start a cycle if water level icons are either yellow or green.

**TIP** If your unit is not directly connected to the drain empty the waste bottle regularly or each time you are filling the clean water reservoir.

## 4.2 Manual Filling Using Quick Connector at Unit Front

The front fill quick connector is for the regular refilling of the clean water reservoir. The Venturi reservoir does not have a front fill quick connector because it is only filled on installation or after cleaning.

1. To use this method, you will need the manual fill container (0.5 US gal / 2 L) with quick connect and tubing (sold as an accessory).
2. Fill the container with distilled water, keeping it horizontal.
3. With the unit powered ON, connect the tube's quick connector to the unit's clean water fill port at the front.

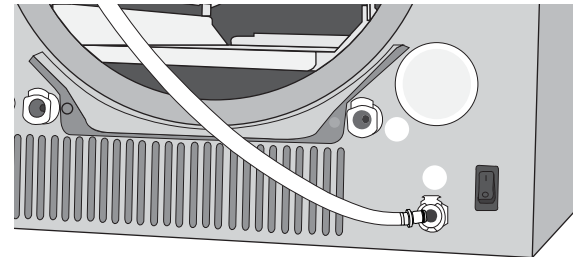
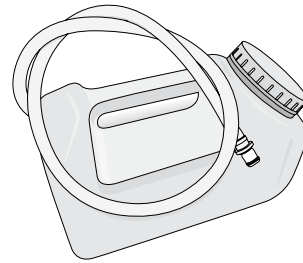

4. Hold or place the manual fill container at a level higher than the unit's fill port and loosen the cap on the container to allow water to flow into the tank.

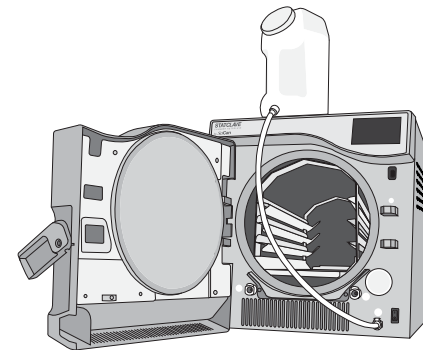

5. With the door open, access the LCD home screen and select any cycle to view the pre-cycle information screen.
6. The clean water level check mark will turn yellow when the minimum water level is reached.
7. Repeat this procedure a second time to fill the water reservoir to max level. (Each fill takes 4 minutes.) Continue until the clean water level indicator turns green and you hear 3 BEEPs.

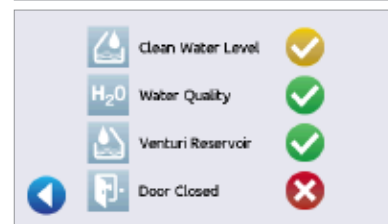
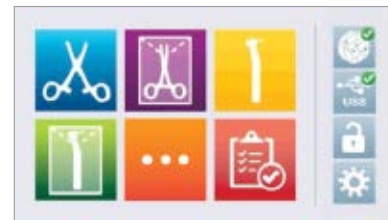

**TIP** You can start a cycle if water level icons are either yellow or green.

**TIP** If your unit is not directly connected to the drain, empty the waste bottle regularly or each time you are filling the clean water reservoir.

## 4.3 Automatic Filling Using a Vista Pure Specialized Water Filtration System with Accumulation Tank

When connecting your STATCLAVE to an external filling device such as a Vista Pure specialized water filtration system, make sure your unit is set to the AUTOMATIC filling mode. (See Setting the water reservoir filling mode in Section 4.)

1. Remove the plug from the automatic fill port (A) at the back of the unit.
2. Connect the water filtration system's Teflon tube (or other suitable tube) to the automatic fill port (A) at the back of the unit.
3. Ensure the tube runs freely from the water filtration system. It should not be sharply bent, crushed or obstructed in any way.
4. Open the valve on the water filtration system (C) to fill the accumulation tank.
5. Open the accumulation tank's valve (B) to facilitate the flow of water to the STATCLAVE.
6. Go to the home screen and select any cycle to activate the filling system.

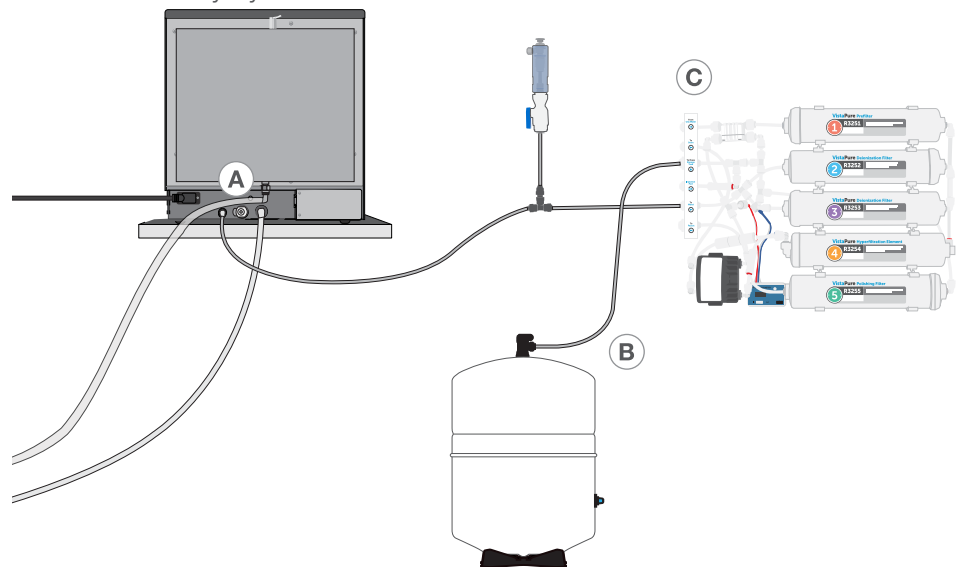
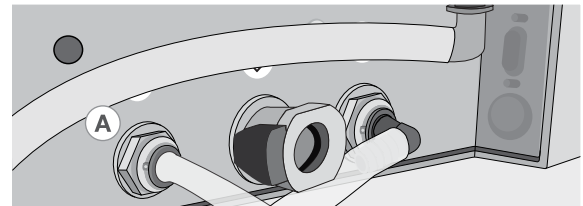
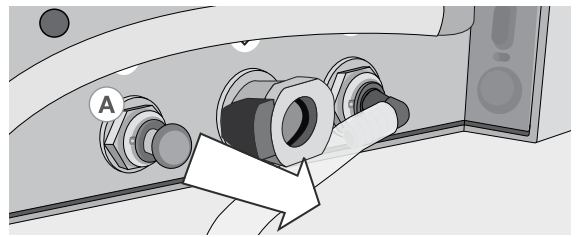

**IMPORTANT!** Before you activate the AUTOMATIC filling mode, make sure the external tank has been filled with high quality distilled water. Also remember to open the tap on the external tank or filtration system, if required.

**IMPORTANT!** When selecting an automatic filling option, it is best to use a direct-to-drain wastewater connection. Use of an external wastewater bottle will require careful monitoring and frequent emptying.

High quality distilled water with a conductivity of 6.4 ppm / 10  $\mu$ S/cm or less is recommended.

## 4.4 Automatic Filling Using External Water Tank and Auxiliary Pump

When connecting your STATCLAVE to an automatic filling system such as an external water tank and auxiliary pump, make sure your unit is set to the AUTOMATIC filling mode. (See Setting the water reservoir filling mode in Section 4.)

An input hose can be connected to the STATCLAVE from an external tank that uses an automatic water pump to feed the internal tank automatically when it reaches the MIN level. Be sure to monitor the water level of your external tank. The STATCLAVE unit does not monitor the water level in the external tank and the auxiliary water pump should not run dry.

To use this method, you will need the STATCLAVE automatic fill pump (sold as an accessory) and an external tank with a minimum diameter opening of 2" (50mm) through which you can insert the pump.

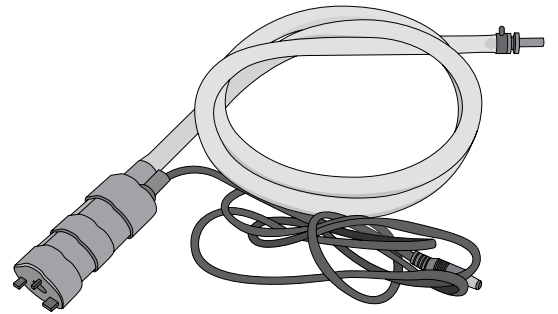

To connect the automatic fill pump to the STATCLAVE, follow these steps:

1. Remove the plug from the automatic fill port (A) at the back of the unit.
2. Connect the fitting at the end of the pump's tubing to the automatic fill port (A).
3. Connect the automatic fill pump's power source to the power connection (B) located at the back of the unit.
4. Fill the external tank with distilled water.
5. Place the submersible automatic fill pump (C) in the external tank.
6. Go to the home screen and select any cycle to activate the filling system.

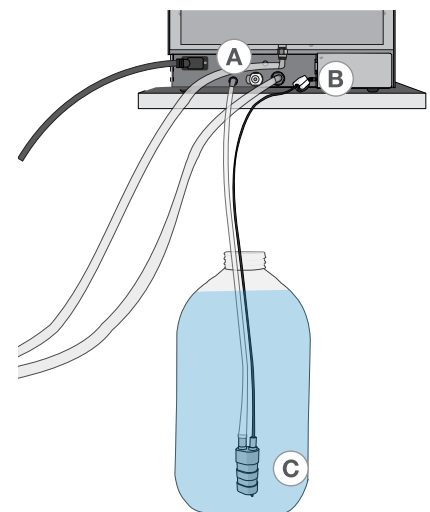
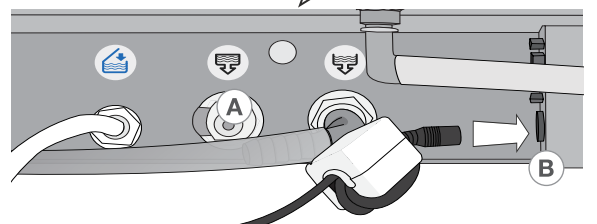
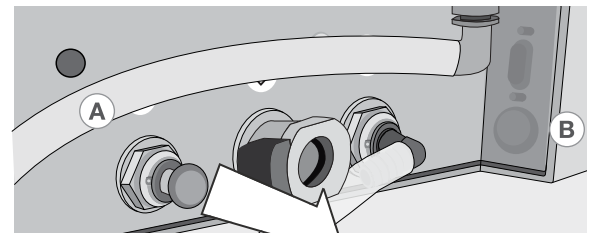

## 5. Loading Instruments

Before loading any instruments into the STATCLAVE, consult the instrument manufacturer's reprocessing instructions to confirm instruments can tolerate steam sterilization temperatures.

The following material can typically be sterilized with steam:

- › Stainless steel surgical/generic instruments
- › Carbon steel surgical/generic instruments
- › Rotating and/or vibrating instruments driven by compressed air (turbines) or mechanical transmission (counter-angles, tooth scalers)
- › Glass articles
- › Mineral-based articles
- › Articles made of heat-resistant plastic
- › Articles made of heat-resistant rubber
- › Heat-resistant textiles
- › Medical textiles (gauze, pads, etc.).

**CAUTION! DON'T use the STATCLAVE to sterilize liquids or pharmaceutical products. This may result in incomplete sterilization and/or damage to the autoclave.**

### Clean Instruments Before Sterilization

It is important to clean, rinse and dry all instruments before loading them into the autoclave. Disinfectant residues and solid debris may inhibit sterilization and damage both the instruments and the STATCLAVE. Lubricated instruments must be wiped thoroughly and any excess lubricant removed before loading.

#### STATCLAVE LOAD CAPACITIES

Load Type	Capacity per Tray	Capacity per Pouch Rack	Total Capacity*
Solid Items	1.5 kg	3 kg	6 kg
Dental Handpieces	1.5 kg	3 kg	6 kg
Rubber and Plastics	0.5 kg	Not applicable	2 kg
Textiles and Packs	Not applicable	Not applicable	2 kg

\* Load capacities listed here are for the total weights of instruments and cassettes or containers not supplied with the unit. DON'T include the weight of the chamber rack, trays, pouch rack or drying plates that are supplied with the unit when calculating your instrument load weights.



## 5.1 Using the Chamber Rack

**IMPORTANT!** DON'T run the STATCLAVE without the chamber rack in place.

### Inserting the Rack

Push the rack into the chamber until it locks into position at the back. The front of the chamber rack should be flush with the chamber flange.

**CAUTION!** Hot Chamber.

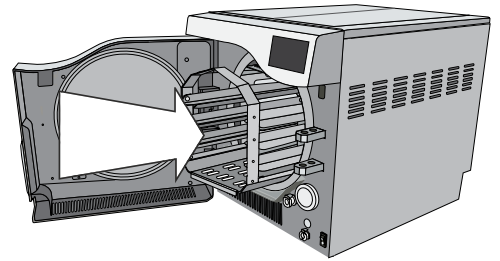

### Using the Rack

#### 1. Tray Configuration

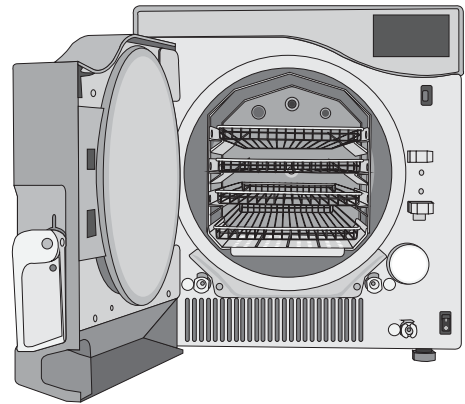
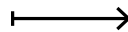
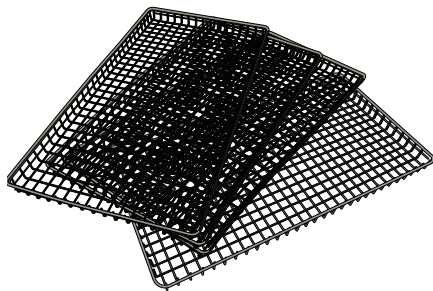

#### 2. Pouch Configuration

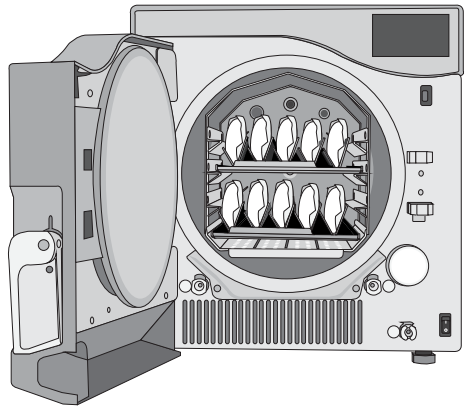
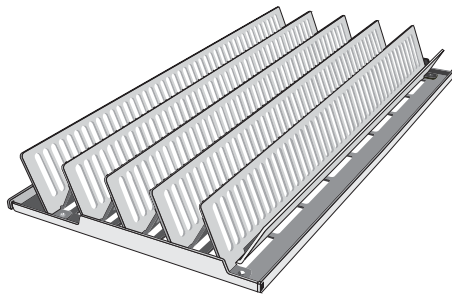

#### 3. Cassette Configuration

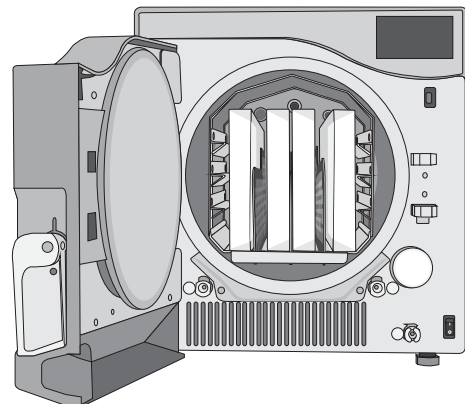
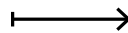
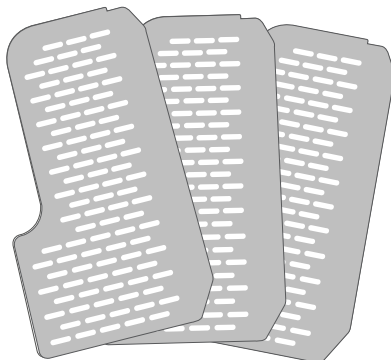

## 5.2 Wrapped Instruments

If you plan to store your instruments after sterilization, wrap them according to the instrument manufacturer's instructions, select the appropriate wrapped cycle and allow it to run to completion. Unwrapped instruments, once exposed to ambient or external conditions, cannot be maintained in a sterile state.

- › **DO** ensure to use only sterilization wraps and pouches that have been cleared for your market.
- › **DON'T** use 100% cellulose sterilization wraps when double-wrapping as these may require longer drying times.

### Using Pouches

**IMPORTANT!** If you are using pouches you **MUST** use the STATCLAVE pouch rack supplied with your unit to ensure optimal drying.

1. Position pouches with the paper side towards the tall support on the pouch rack. This will optimize drying.
2. Arrange pouches 2 per row to a maximum of 10 pouches to a rack.
3. Load one pouch rack on the bottom rail and the other on the second from top rail.

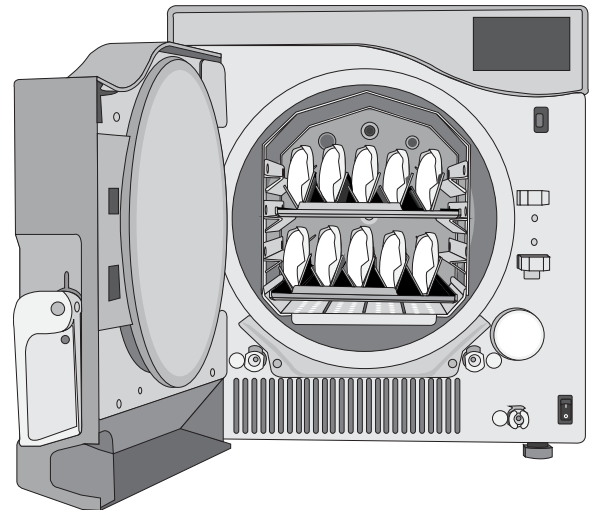
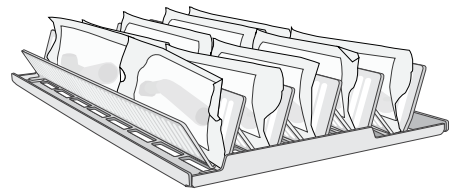

**CAUTION!** Water droplets and visible signs of moisture on sterile packaging or the tape used to secure it, may compromise sterility of processed loads or be indicative of a sterilization process failure. Visually check outside wrapper for dryness. If there are water droplets or visible moisture on the exterior of the package or on the tape used to secure it, the pack or instrument tray is considered unacceptable.

- › **DO** use the STATCLAVE pouch rack supplied with your unit to position pouches on their sides.
- › **DO** always check that pouches are placed correctly: with the paper side against the rack's tall supports.
- › **DO** package instruments individually. If you are placing more than one instrument in the same pouch, ensure they are made of the same metal.
- › **DON'T** stack pouches or wraps. Instead, use the pouch rack to keep pouches vertical. This will promote drying and enable effective sterilization.
- › **DON'T** store pouched or wrapped loads that are wet. If the wraps on a wrapped load are not dry when the load is removed, the instruments must be handled in an aseptic manner for immediate use or re-sterilized.

## Using Wrapped Cassettes and Containers

Drying plates must be used when processing wrapped cassettes to ensure air flow around cassettes and to promote proper drying.

For wrapped loads, place a chemical indicator inside each of the wrappings.

### Inserting drying plates

1. Remove the wire trays from the unit and insert the drying plates into each of the slots in the base of the rack.
2. The three plates should sit vertically, evenly placed in the rack.
3. Place cassettes vertically into the unit to optimize drying.

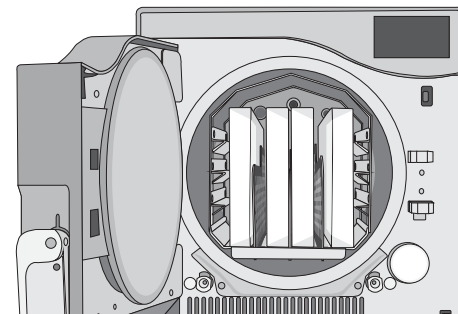
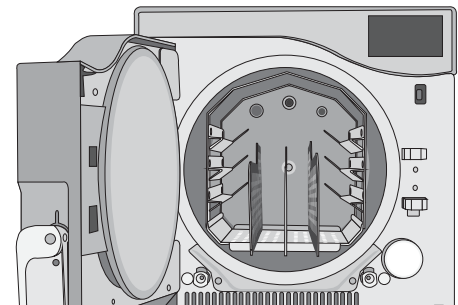
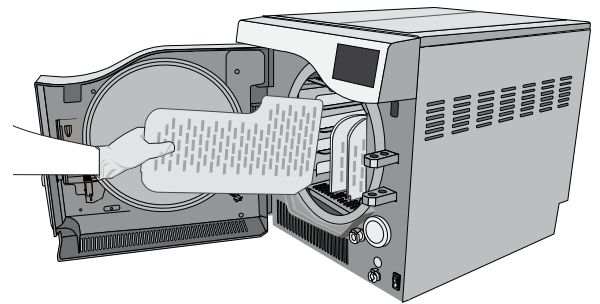

### When Using Wrapped Cassettes:

- › **DO** ensure you always use suitably porous material (sterilization paper, muslin napkins, etc.) and close the wrapping with adhesive tape designed for use in autoclaves.
- › **DO** ensure there is space for sufficient air flow between cassettes when loading more than one wrapped cassette per row.
- › **DO** always use adhesive tape designed for autoclaves or heat-sealing machines. Using staples, pins or other fasteners could compromise the sterility of the load.
- › **DO** be sure to insert wrapped cassettes with the flat side down to avoid tearing the wrap.

## Using Rigid Sterilization Containers

The STATCLAVE is capable of processing re-usable rigid sterilization containers, which can be used as an alternative to wrapping cassettes. These provide a convenient way to organize and store instruments. Check the sterilization container manufacturer's instructions to determine its suitability for pre-vacuum steam sterilization.

### When Using Rigid Sterilization Containers:

- › **DO** ensure drying plates are used and that the rigid sterilization containers are placed vertically in the rack to promote proper drying. (See Inserting drying plates, above.)
- › **DO** ensure there is space for sufficient air flow between the rigid sterilization containers when loading more than one container per row.

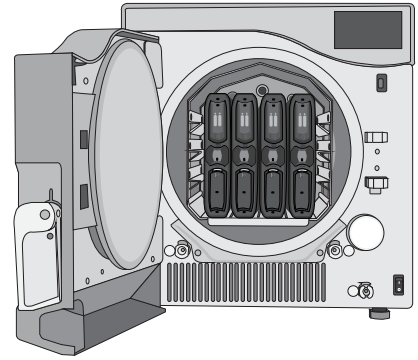

## 5.3 Unwrapped Instruments

Unwrapped instruments are also referred to as Immediate Use Instruments because once exposed to ambient or external conditions, they cannot be maintained in a sterile state. If you plan to store your instruments after sterilization, wrap them according to the instrument manufacturer's instructions, select the appropriate wrapped cycle and allow it to run to completion.

- › **DO** use the trays provided with your unit to hold unwrapped instruments.
- › **DO** always use the trays with the chamber rack provided.
- › **DO** always use the extractor provided to remove trays from the sterilization chamber.
- › **DO** arrange instruments made of different metals (stainless steel, tempered steel, aluminum, etc.) on different trays or keep them well separated from each other.
- › **DO** arrange receptacles upside down to prevent water from pooling inside.
- › **DO** ensure objects on trays are always arranged with some distance between them ensuring they will remain in the same position for the entire sterilization cycle.
- › **DO** ensure that hinged instruments are sterilized in an open position.
- › **DO** position cutting instruments, (scissors, scalpels, etc.) so that they do not come into contact with each other during sterilization.
- › **DON'T** load the trays beyond their maximum indicated limit. (See STATCLAVE Load Capacities chart at the start of Section 5. Loading Instruments)
- › **DON'T** stack trays or put them in direct contact with the sterilization chamber walls.

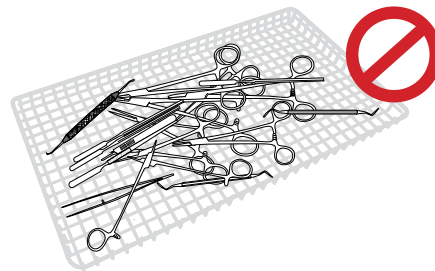
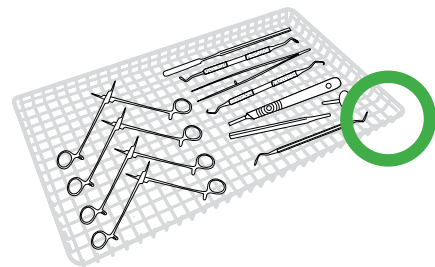

## 5.4 Rubber and Plastic

The following materials CAN be sterilized in the STATCLAVE:

- › Nylon, polycarbonate (Lexan™), polypropylene, PTFE (Teflon™), acetal (Delrin™), polysulfone (Udel™), polyetherimide (Ultem™), silicone rubber, and polyester.

When loading rubber and plastic tubing on the tray, ensure they do not touch the chamber walls. This ensures that steam reaches all surfaces, and will promote drying.

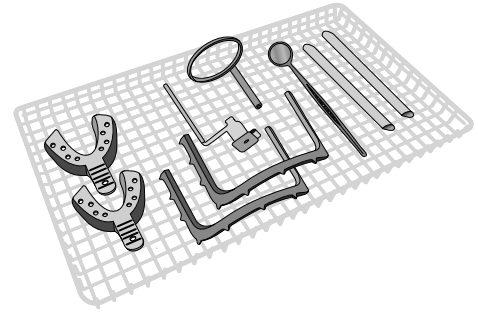

- › **DO** arrange receptacles upside down to prevent water from pooling inside.
- › **DO** process dental impression trays on the top tray to optimize drying.
- › **DO** process on the top tray any items with shapes that could collect water.

### TIP

#### Additional tips for rubber and plastic:

- › Arrange the tubing on the tray so that ends are not obstructed or crushed.
- › DON'T bend or wind tubes. Allow tubes to lie as straight as possible.

#### **IMPORTANT!** DO NOT attempt to sterilize the following materials in the STATCLAVE:

Polyethylene, ABS, styrene, cellulose, PVC, Acrylic (Plexiglas™), PPO (Noryl™), latex, neoprene, and similar materials.

Use of these materials may lead to instrument or equipment damage. If you are unsure of your instrument's material or construction, do not sterilize it in your STATCLAVE until you have checked with the instrument manufacturer.

## 5.5 Textiles and Surgical Packs

Carefully wash and dry textile materials (or porous materials in general), such as smocks, napkins, caps and other, before treating these in the autoclave. Do not use detergents with a high content of chlorine and/or phosphates and do not bleach with chlorine-based products. These substances can damage the tray supports, trays and any metal instruments that may be present in the sterilization chamber.

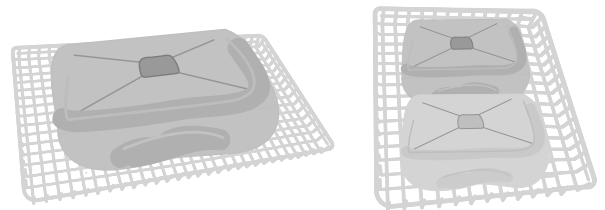

## 5.6 Using Biological and Chemical Indicators

Use chemical process monitors suitable for steam autoclaves/sterilizers at the indicated cycle temperatures and times in or on each package or load being sterilized.

**CAUTION! Only use FDA-cleared chemical and biological indicators. They should be designed for the particular sterilization cycle temperature and exposure time being monitored.**

## 6. Using Your STATCLAVE

### 6.1 Running a Cycle

Once the autoclave has been correctly installed and before using your STATCLAVE for the first time, make sure BOTH the clean water reservoir and Venturi reservoir are full. Refer to Section 4. Filling the Water Reservoirs for detailed instructions.

**1. Power on the unit**

The main switch is located below the door handle.

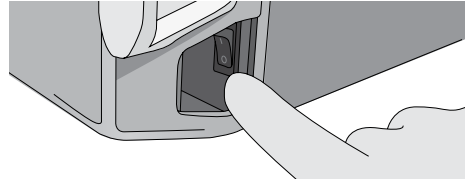

**2. Ensure both reservoirs are full**

You will not be able to start a cycle if the reservoir levels are below the minimum fill lines.

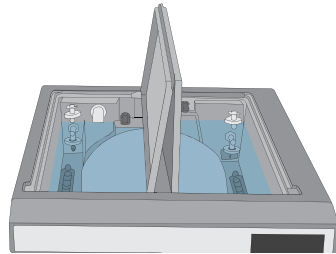

**3. Open the door**

The LCD should display the UNLOCKED icon. Pull up on the handle to disengage the manual latch and open the door. If the door will not open, press the LOCK icon to go to the door lock status screen and press the UNLOCK icon.

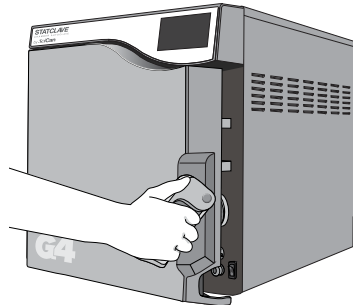

**CAUTION! Hot Chamber.**

The unit's Stand-by mode is preset to maintain a hot chamber. To avoid burns, take care not to touch the chamber, rack or door with bare hands.

**4. Load the instruments**

To ensure correct loading, see Section 5. Loading Instruments.

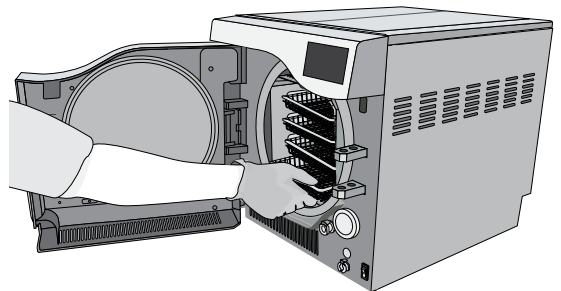

## 5. Close the door

Close the door by locking the handle into position. When you close the door, you will hear the sound of the vacuum system adjusting chamber pressure to seal the door. This is a normal operating sound.

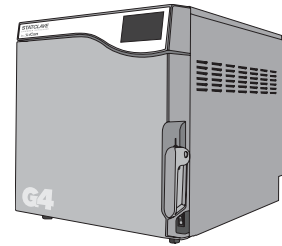

## 6. Select the cycle

From the LCD, select the cycle you want to run. To learn more about the available cycles, see Section 7. Sterilization Cycles. Press the icon to see the cycle name and parameters.



**If User PIN ID has been enabled**, you will be prompted to enter your User ID and PIN before your cycle selection is accepted.



**If there is a problem with the door lock or water**, a PRE-CYCLE SCREEN will appear:

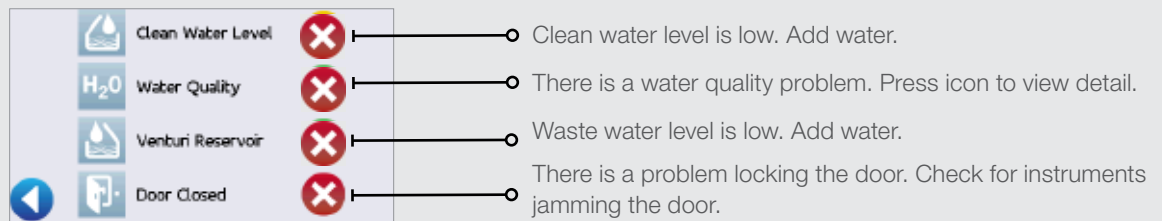

## 7. Press start

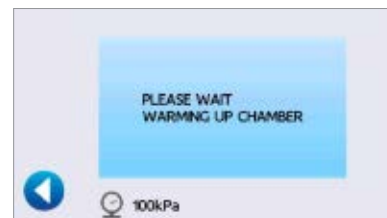
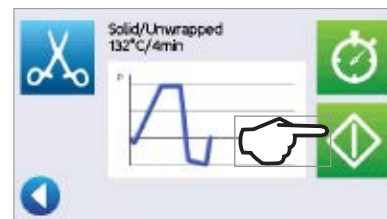

If the chamber is cold, warming up can take up to 12 minutes.

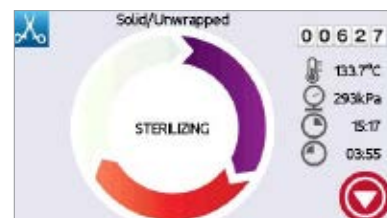

Allow the cycle to run to completion.

## 8. Cycle is complete.

When the cycle is complete, press STOP to release the load.



**IMPORTANT!** When the drying stage is finished, the display will show the cycle is complete.

## 9. Remove the load

Open the door. Using the tray extractor, remove the trays.

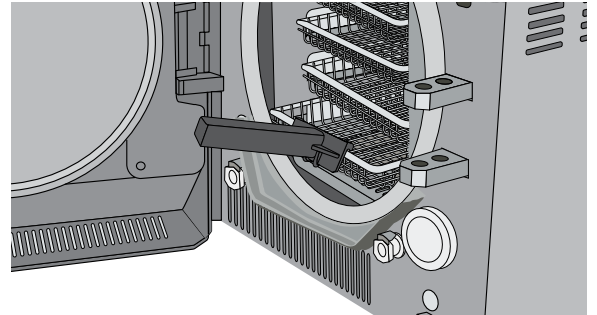

### CAUTION!

The metal parts will be hot.

### CAUTION!

If the screen displays a **CYCLE FAULT** code or a **NOT STERILE** message, the contents are not sterile. See Section 11. Troubleshooting for more information.

Water droplets and visible signs of moisture on sterile packaging or the tape used to secure it, may compromise sterility of processed loads or be indicative of a sterilization process failure. Visually check outside wrapper for dryness. If there are water droplets or visible moisture on the exterior of the package or on the tape used to secure it, the pack or instrument tray is considered unacceptable.

## 6.2 Stopping a Cycle

To stop a cycle BEFORE sterilization is complete, press the **STOP** icon at the bottom right of the touchscreen:

1. If you stop the cycle **before sterilization** is complete, the unit will remind you that the load is **NOT STERILE**.

2. Press **STOP** to continue.

To stop a cycle DURING the drying phase, press the **STOP** icon at the bottom right of the touchscreen:



1. If you stop the load **during the drying phase**, the unit will remind you to **CHECK FOR DRYNESS**.

2. Press **STOP** to continue.

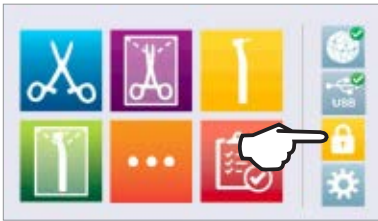
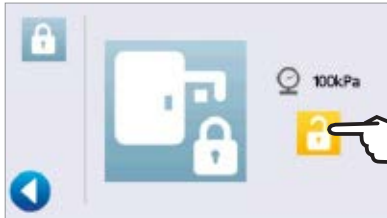

## Opening the door after pressing STOP

Once a cycle has been stopped, the **STOP** button must be pressed to return to the home screen and start a new cycle. To start a new cycle or to release the load:

- 
- 
- 
- 

**TIP** If **Process Enforced usage is enabled**, a PIN screen will appear after you have pressed **STOP**. To release the load manually, press **EN** on the PIN screen. On the next screen, select **RELEASE LOAD MANUALLY**.

## 6.3 Using the Start Delay

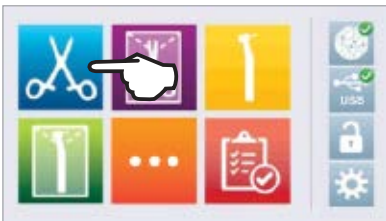
- 
- 
- 

Enter the number of hours and minutes for the start delay.
- 

Press  to begin the countdown.

Press  to stop and reset countdown.

The LCD will remain in countdown mode until the cycle begins.

## 6.4 Emergency Door Opening

The STATCLAVE is equipped with a safety mechanism that automatically regulates the chamber pressure when the unit loses power. The unit will take approximately 2 minutes to depressurize. You will hear a bubbling sound as chamber air is exhausted into the wastewater reservoir. But, without power, the door lock remains engaged. To unlock the door without power, follow these steps.

1. Remove the emergency door unlocking pin located in the handle of the tray extractor supplied with your STATCLAVE.

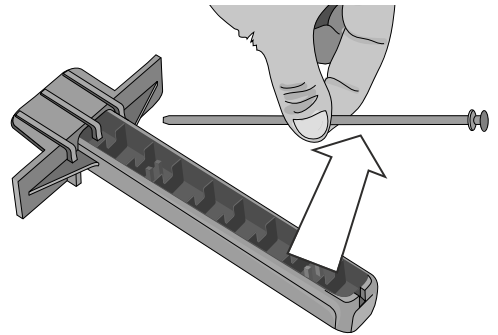

2. Insert the emergency door unlocking pin into the small hole on the side of the unit's handle. Push the pin into the hole as far as it goes to trigger the door release.

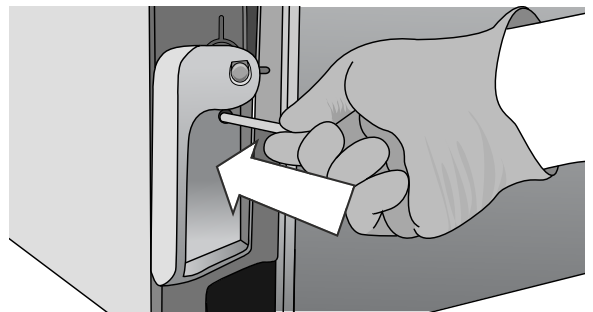

3. Remove the emergency door unlocking pin from the hole in the door handle.

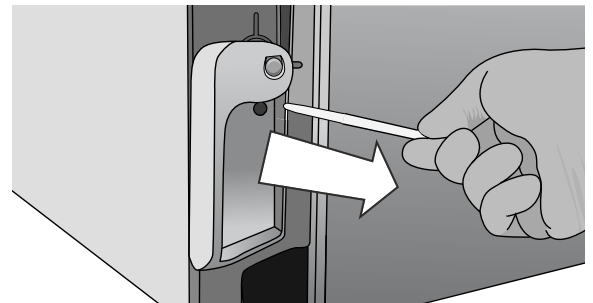

4. Pull up on the handle to open.

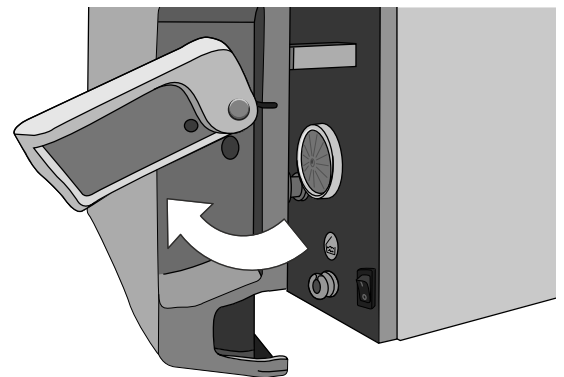

### **CAUTION! Risk of Injury.**

Do not force the door handle. If the handle does not unlatch easily, allow the unit to cool for 10 minutes before attempting again.

## 6.5 Running a Vacuum Test

The vacuum test checks the autoclave's plumbing system for leaks and should be done on a regular basis in accordance to your local guidelines. Run this test with the rack and empty trays in the chamber.

**IMPORTANT!** Vacuum tests must be conducted when the unit is cool. Running a vacuum test on a hot chamber may cause the test to fail.

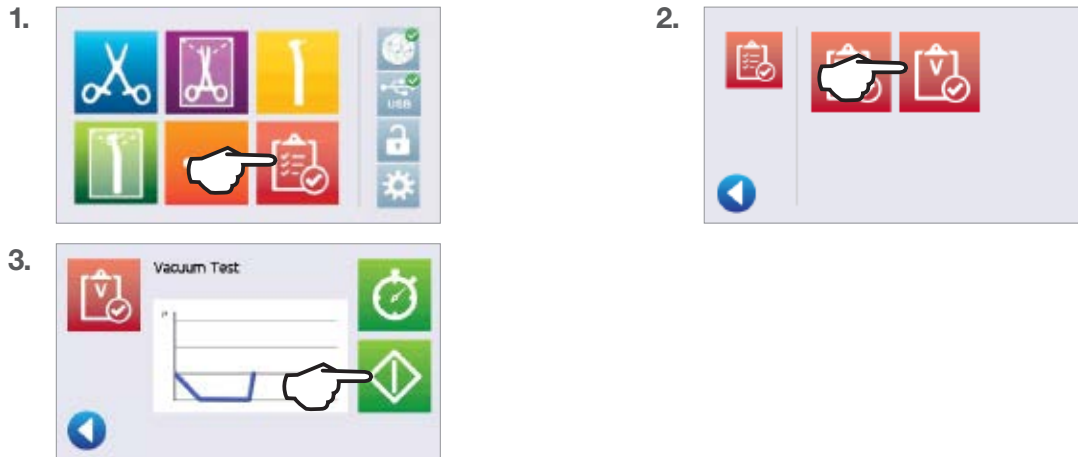

Running a vacuum test can take a minimum of 45 minutes. When the test is complete, the screen will display a CYCLE COMPLETE message. If the test has failed, see Section 11. Troubleshooting.

### Presetting your vacuum test

To schedule a vacuum test before the start of the next working day, use the delayed start function.

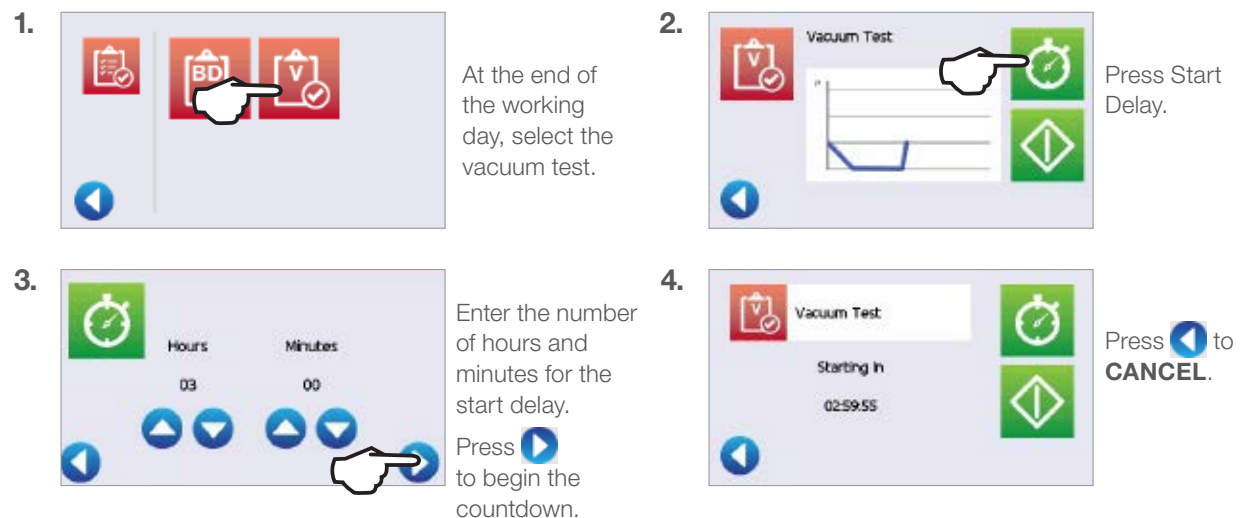

**IMPORTANT!** When using the delayed start with your vacuum test...

Make sure the vacuum test is scheduled at a time when the chamber is cold. A warm chamber may cause the vacuum test to fail. Set your vacuum test to start at least 1 hour before your unit begins to warm the chamber. NOTE: The STATCLAVE's default setting is to keep the chamber temperature at Stand-by HIGH from 7:00 a.m. to 8:00 p.m.

## 6.6 Running a Bowie-Dick Test

The BOWIE-DICK test is used to ensure proper air removal is occurring in a pre-vacuum autoclave. Complete air removal is important because pockets of cool air remaining in the chamber can compromise sterilization. Using an FDA-approved Bowie-Dick test pack, the Bowie-Dick test runs a cycle at 134°C for 3.5 minutes to evaluate the correct air removal.

To perform a Bowie-Dick test, you will need a Bowie-Dick device or test pack. These are NOT supplied with your STATCLAVE. To perform the test, follow the instructions provided by the test manufacturer. Generally, the process is as follows:

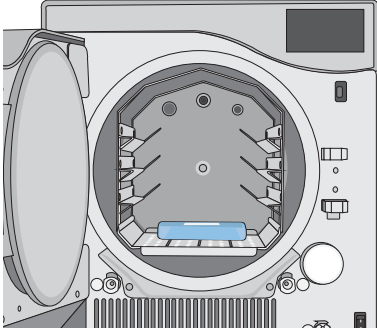
- 

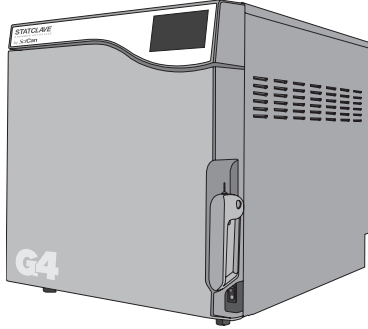
1. Open the unit's chamber door to insert a Bowie Dick test pack. (Position pack at center back.)
- 

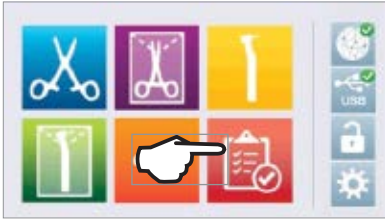
2. Close and lock the door.
- 

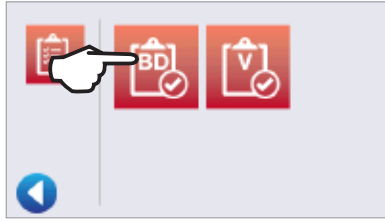
3. From the home screen, select the **TESTS** icon.
- 

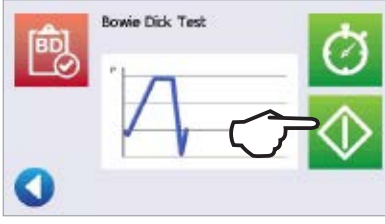
4. To run a Bowie Dick Test, press the **BD** icon.
- 

5. Press **START**.
- 

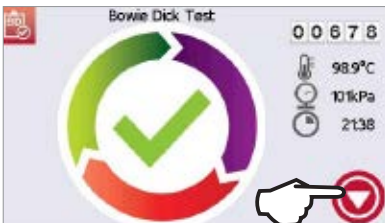
6. Allow the test to run to completion.
- 

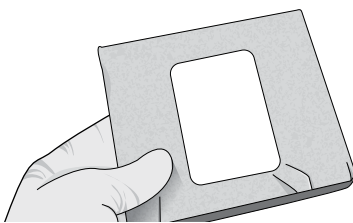
7. Press **STOP** to release the load.
- 

8. Follow the test manufacturer's instructions to interpret the test results.

If the unit passes the test, it is ready for use. If the unit fails, check the test manufacturer's instructions and repeat the test.

## 7. Sterilization Cycles

The STATCLAVE features 6 validated sterilization cycles with optimized drying for the fast, effective sterilization of the various types of loads used in a medical or dental environment. The table below describes load types and corresponding sterilization requirements. Load size requirement details are listed in *Section 5. Loading Instruments*.

**NOTE:** When selecting a sterilization cycle, choose according to the load you are sterilizing and the instrument manufacturer's reprocessing instructions.

### STERILIZATION CYCLE INFORMATION



Cycle	Load Type and Weight	Sterilization Temperature and Time	Drying Time
Solid/ Unwrapped 	<b>IUSS CYCLE*</b> for unwrapped solid instruments (mirrors, explorers), hinged instruments (hemostats) on trays.  Maximum Load: 6 Kg /13.2 lbs	132°C /270°F for 4 minutes	Not applicable
Solid/Wrapped 	Wrapped IMS cassettes with solid instruments, rigid sterilization containers with solid instruments or single-pouched solid instruments on a pouch rack.  Maximum Load: 6 Kg /13.2 lbs	132°C /270°F for 4 minutes	25 minutes (up to 6 kg / 13.2 lbs of load)  15 minutes (up to 1.4 kg / 3 lbs of load**)
Hollow/ Unwrapped 	<b>IUSS CYCLE*</b> for unwrapped dental handpieces on trays.  Maximum Load: 6 Kg /13.2 lbs	132°C /270°F for 4 minutes	Not applicable
Hollow/ Wrapped 	Single-pouched dental handpieces on a pouch rack.  Maximum Load: 6 Kg /13.2 lbs	132°C /270°F for 4 minutes	25 minutes (up to 6 kg / 13.2 lbs of load)  15 minutes (up to 1.4 kg / 3 lbs of load)
Textiles/Porous 	Textiles  Maximum Load: 2 Kg /4.4 lbs	132°C /270°F for 4 minutes	20 minutes
Rubber & Plastic 	<b>IUSS CYCLE*</b> for unwrapped solid or hollow instruments constructed of metal, rubber and plastic.  Maximum Load: 2 Kg /4.4 lbs	121 °C /250°F for 20 minutes	Not applicable

\*Immediate Use Steam Sterilization cycle.

\*\* For optimal drying of these loads, use only one pouch rack loaded on the second from top rail.

## 8. Using and Changing Settings

The STATCLAVE user menu provides you with access to settings that can be adjusted or changed. The chart below offers an overview of where these settings can be found within the menu structure and tells you what you can do with each button. Functions such as setting up load traceability, User IDs and PINs, setting drying times and Stand-by mode are explained in more detail later in this chapter.

To access this menu from the home screen, select  then . Use the **UP** and **DOWN** arrows to navigate the menu. Press on a button to make a selection. Press the **BACK** button to move to a previous screen when navigating the menus. After changing a setting, press the **BACK** button to save your selection.

USER MENU BUTTONS	SUBMENU BUTTONS	WHAT TO DO WITH IT
General	Time	Enter values
	Date	Enter values
	Set Time Zone	Select zone
	Time Update	Select automatic or manual
	Time 12/24	Select 12-hour or 24-hour format
	Date Format	Select how date is displayed
	Country	Type name to select country
	Units	Select metric or imperial
Language		Select from language list
Unit No.		For users with multiple units
Printer	Printer Type	Select serial or no printer
	Baud Rate	For printer adjustments
	End of Line CR/LF	For printer adjustments
	Printer user ° char	For printer adjustments
Process	Enforced	Select ON, OFF or DOCUMENTATION
	User	Create User ID and PIN. Up to 20 users.
Screen	Screensaver	Adjust the time delay for the screensaver.
	LCD Contrast	Adjust LCD readability
	Cycle Run	Select circle or chart graphic to display during a cycle
Network Setup	Network	Select WiFi or wired connection
	Automatic IP (DHCP)	Network connection
	Renew IP	Network connection



<b>Sound</b>	<b>Button Beep</b>	Turn the beep ON or OFF
	<b>Beep Volume</b>	Adjust sound
<b>Instructions</b>	<b>Water Reservoir Filters</b>	Slide show on how to clean the filters
<b>Drying</b>	<b>Solid/Unwrapped 132°C/4 min</b>	Adjust drying time (0 to 60 minutes)
	<b>Solid/Wrapped 132°C/4 min</b>	Adjust drying time (0 to 60 minutes)
	<b>Hollow/Unwrapped 132°C/4 min</b>	Adjust drying time (0 to 60 minutes)
	<b>Hollow/Wrapped 132°C/4 min</b>	Adjust drying time (0 to 60 minutes)
	<b>Textiles/Porous 132°C/4 min</b>	Adjust drying time (0 to 60 minutes)
	<b>Rubber &amp; Plastic 121°C/20 min</b>	Adjust drying time (0 to 60 minutes)
<b>Online</b>	<b>Online Access</b>	Enter an email to receive notifications.
	<b>Privacy</b>	Agree: Your unit will send cycle data and unit errors to SciCan. It will also receive automatic software updates to the user interface. Disagree: Your unit will NOT send any cycle information but it will receive automatic software updates to the user interface.
	<b>Intro</b>	Select ON, then turn the unit OFF using the power switch. The start-up screen and connection wizard will begin when the unit is next powered ON.
	<b>Remote Access</b>	Use to generate a token that can be sent to a technician who can access your unit remotely.
	<b>Notifications</b>	Enter email addresses (max. 4) to which unit can send notifications.
<b>Water Filling</b>	<b>Auto / Manual</b>	Select auto when using an external auto fill system. Default is manual.
<b>Stand-by</b>	<b>Stand-by On/Off</b>	Select high, low or off. Default is high.
	<b>Stand-by Start</b>	Enter time value. Default is 07:00.
	<b>Stand-by End</b>	Enter time value. Default is 20:00

## 8.1 Setting Up Load Traceability with User ID, PIN and Process Enforced Usage

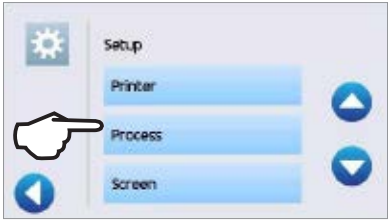

Process Enforced Usage keeps track of who has started and who has removed a load from your STATCLAVE. It does this by prompting users to enter a PIN at the start of a cycle, when they stop or cancel a cycle, and when they remove a load. Process Enforced Usage does not restrict any functions, it is simply a means of tracking whether a registered user or unregistered user was operating the unit.

Process Enforced Usage in DOCUMENTATION mode prompts the user to enter information about the load type and indicators used to collect additional data that is stored with the cycle's record. For the Process Enforced feature to function, User IDs and PINs must first be assigned.

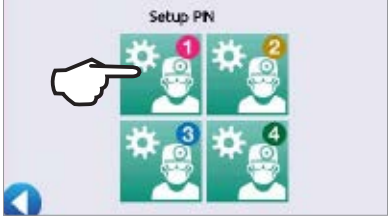

To set up a User ID and PIN, select  then  and follow these steps:



- 
  - 
  - 

Select a User icon to assign it a PIN. There are 20 User icons to choose from.
  - 

Using the keypad, assign a PIN of up to four digits. Press **EN** to save. Press  to move to the confirmation screen.
  - 

If all of the information presented in the confirmation screen is correct, press **OK** to be returned to the USER screen.
- TIP** To make a correction, select the PIN User you want to change and repeat the process described above.

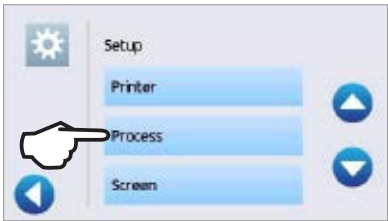
To turn Process Enforced Usage ON or OFF, or to activate DOCUMENTATION mode, select  then  and follow these steps:

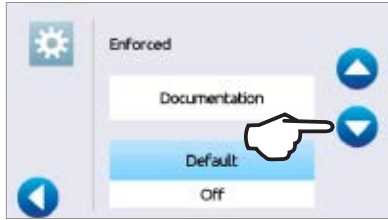
- 
- 
- 

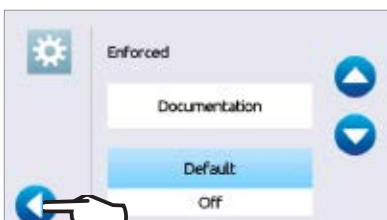
Use the arrows to select **ON**, **OFF** or **DOCUMENTATION**.
- 

Press  to save your change and return to the main menu.

**TIP** Any user can stop a cycle and remove the load even with the Process Enforced feature ON. However, the cycle data will record that an unregistered user has stopped the cycle and/or opened the door.



## Using Process Enforced Documentation mode:

This mode activates the process enforced usage function along with the additional documentation function that generates a report with information about the cycle and the load type.

**When starting a cycle** with Process Enforced Documentation mode turned ON, you will be prompted to identify the general contents of the load to be processed by selecting from a list as well as whether a biological indicator and chemical indicator are included.



**At the end of the cycle**, you will be prompted to report whether the indicators have passed and whether the load is dry (as applicable).

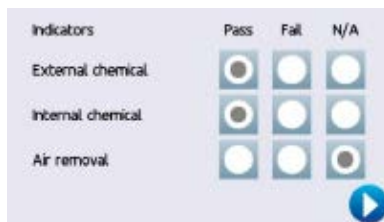

Biological Indicator/Spore test results are available at a different time than chemical indicators but you still have the option to add the BI/Spore test results to the documentation report when these results are available.

On the home screen, the STATCLAVE will indicate a result is pending by showing this icon:



Pressing this button will lead you to a screen that allows you to input the Biological Indicator results.

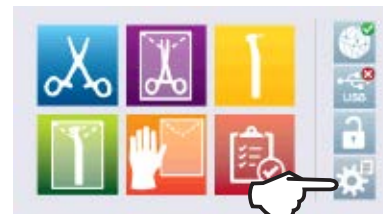

## 8.2 Setting Drying Time

Use this setting to select drying times. The default drying times for each cycle are preset to provide optimal drying of a maximum load. Drying times may be adjusted for smaller loads as detailed in Section 7. Sterilization Cycles.

**CAUTION! Instruments in pouches or wraps that are not completely dry must be used immediately or reprocessed.**

To change drying times, select  then  and follow these steps:

- 



Go to DRYING.
- 

Select the program whose drying time you would like to change.

## 8.3 Setting the Stand-by Mode

Using this setting will reduce the warm-up time between cycles by keeping the chamber at a temperature that is optimal for your office's level of use.

- › **STAND-BY LOW:** For low to average use. Provides a balance between keeping the chamber at 70°C and using a minimum of electricity.
- › **STAND-BY HIGH:** For high use. Optimizes your STATCLAVE for speed by keeping the chamber at 120°C. This is the unit's default setting.
- › **STAND-BY OFF:** For infrequent use. Select if you are using your STATCLAVE infrequently. In this setting, the wait time will be longer (up to 12 minutes from a cold start).

To change this setting and to modify the amount of time the unit is in Stand-by, select  then  and follow these steps:

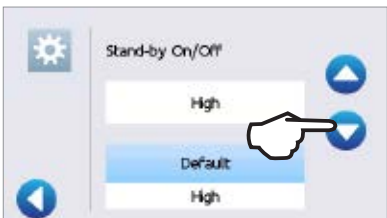
- 
- 



Use the **arrows** to select Stand-by HIGH, LOW or OFF.
- 

If HIGH or LOW is selected, you will be prompted to enter a START and END time for the Stand-by mode.
- 

Once you have entered the END time, press **EN** to save and press **BACK** to return to the previous menu.

**TIP** To improve drying performance, ensure the unit is set to Stand-by HIGH.

**TIP** The STATCLAVE's default setting is to maintain the unit at Stand-by HIGH from 7:00 a.m. to 8:00 p.m. For this feature to function correctly, your unit must be set to the correct time, date and country.



1. Press  to verify that your unit is set to your local time and date.
2. To update this information, from the **SETTINGS** screen, select  and **GENERAL**.
3. Select the item (**TIME, DATE, COUNTRY**) you would like to update and enter the correct values.

## 8.4 Setting Up and Using Your STATCLAVE Web Portal

The web portal provides a direct connection to the STATCLAVE on your local area network. It is protected by your firewall and not accessible to outside users (unless they have a Remote Access Code. For more information, see *Section 10.13 Allowing a technician to access your STATCLAVE from a remote location*).

The web portal displays real-time cycle information and has an archive of sterilization records unique to this unit. From the web portal, you can print reports, set up email notification and search cycle history.

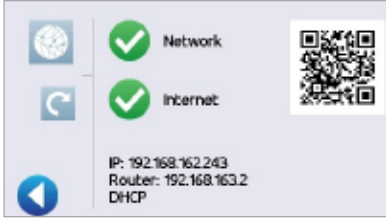
To access your web portal, follow these steps:

-  Press the connectivity icon.
-  The connectivity screen displays information about your STATCLAVE's Internet connection, including its IP address.
-  Type the IP address displayed on the touchscreen into the browser of any web enabled device to access your unit's web portal. To set up your web portal, follow the instructions available on the portal's **HELP** tab.

**TIP** Using a portable device? Scan QR Code to easily access your unit's web portal.

## 8.5 Registering for STATCLAVE Online Access

- From the **Setup** menu, select **Online**, then **Online Access** and follow the steps below:
-  
  -  To use ONLINE ACCESS, you must agree to the Privacy Policy. Select **FORWARD**.
  -  Enter your email. A confirmation email will be sent to your inbox.
  - 

**TIP** To cancel, scroll to privacy in the STATCLAVE's User menu and disagree.

**TIP** If you did not receive a confirmation email, check your Spam folder.

## 9. Storing, Retrieving and Printing Sterilization Records

The STATCLAVE's internal memory is capable of storing data on every cycle, whether successful or incomplete, for the lifetime of the unit. You can access this information through the unit's touchscreen or through the web portal, and retrieved by using a USB storage device or by connecting a printer.

### 9.1 Retrieving Cycle Information Using the Touchscreen

You can always see the last five successful cycles and the last five incomplete cycles, whether you have a USB storage device attached to the unit or not.

-  Press the USB icon.
-  Press on a cycle information button to see its details.

**The unit will record the last five successful cycles and the last five incomplete cycles (incomplete cycles will be identified with a CF number).** If you select a cycle from the list, it will display cycle information in a format similar to how it would be printed.

### 9.2 Retrieving Cycle Information Using the Web Portal

Use the STATCLAVE Web Portal to access all the cycle information stored on your STATCLAVE from your computer. If your STATCLAVE was not connected to a network during the initial installation, follow the instructions in Section 2.4 Connecting your STATCLAVE to a network.

### 9.3 Retrieving Cycle Information Using the USB Data Back Up

The USB storage device can be used to transfer cycle information stored in the unit to a computer. Best practice suggests this should be done once a week. **To transfer data using the USB port, follow these steps:**

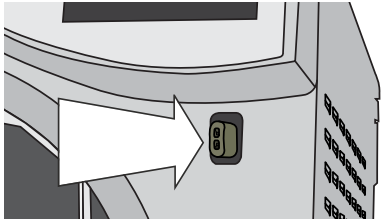
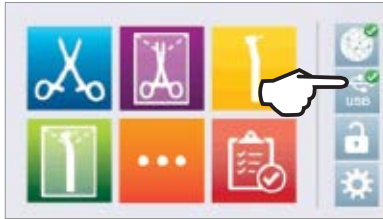
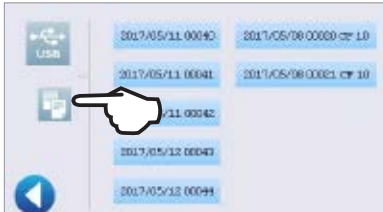
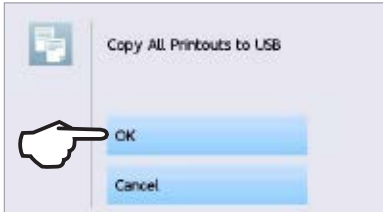
-  Insert the USB storage device into the USB port.
-  Press the USB icon.
-  Press the Copy icon.
-  Press OK to copy cycle data to the USB device inserted.

**IMPORTANT!** Data stored in the internal memory of the STATCLAVE can only be copied once. Data that has been previously transferred will not be re-saved onto a new USB storage device. You can access previously transferred information from your STATCLAVE G4's Web Portal.

When the activity light on the USB storage device stops blinking or the USB icon on the LCD turns from a flashing green to a solid gray, remove the USB storage device and transfer the information to your computer.

**IMPORTANT!** If you select the USB storage device icon from the main menu, you will only be able to view the last five complete cycles and the last five incomplete cycles. To view all the cycles stored on the USB storage device, you must connect the device to your computer.

## 9.4 Connecting to a Printer

To connect the printer, follow these steps:

Connect the external printer to the STATCLAVE's RS232 port using the serial printer cable supplied with your printer.

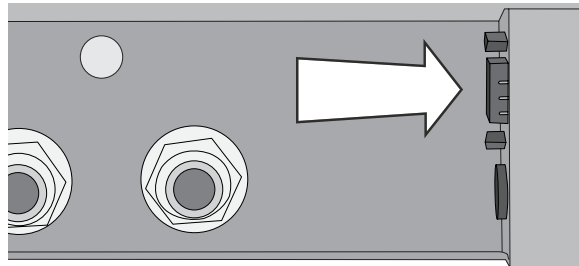

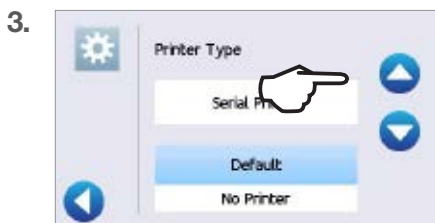

Power on the printer. From the home screen, select  then  and follow these steps:



Use the arrows to scroll to **SERIAL PRINTER** option and select. Press **BACK** to save.

## 9.5 Adjusting your Print Settings

The STATCLAVE allows for several printer adjustments. To access these settings, select  then  and follow these steps:



Use the arrows to scroll through the settings.



Use the table below or your printer's operator manual to make the correct adjustments to your printer's Baud Rate, End of Line CR/LF and Printer User Char.

## 9.6 External Printer Specifications

<b>Recommended Printer</b>	<b>End Of Line CR/LF</b>	<b>Serial Port Bitrate</b>	<b>Printer user ° char</b>
Epson TM-U220D (C31C515603)	CR/LF	9600	248 [0xF8]

Under normal storage conditions, a thermal document will remain legible for a minimum of 5 years. Normal storage conditions of thermal documents include avoiding direct sunlight, filing in office temperatures below 25 degrees Celsius and moderate humidity (45% - 65% relative humidity) and not next to incompatible materials including plastic, vinyl, hand lotion, oil, grease, alcohol-based products, carbonless paper and carbon paper.

## 10. Maintenance Procedures

Regular maintenance will ensure the safe and efficient operation of your STATCLAVE. Before performing any of the cleaning and maintenance procedures described in this chapter, power OFF the unit and disconnect it from its power source.

### CAUTION! Hot Surfaces.

The STATCLAVE chamber's Stand-by mode maintains an optimal operating temperature during working hours. Unless this feature is disabled (See Section 8.3 Setting the Stand-by Mode), the chamber will remain hot between cycles throughout the work day. Make sure the STATCLAVE is properly cooled before accessing the chamber to perform any maintenance.

- › DO always use SciCan replacement parts.
- › DON'T use abrasive cloths, metal brushes or metal-cleaning products, whether solids or liquids, to clean the device or sterilization chamber.

### 10.1 Preventative Maintenance Message

Frequency: Message will appear every 6 months or 500 cycles.

When a maintenance message appears, you have 2 options:

#### OPTION 1: OK



Press **OK** to clear the message. You can continue to use your STATCLAVE or perform the required maintenance. When you press **OK**, the maintenance notification counter will restart the counter, regardless of whether or not you have performed the maintenance.

#### OPTION 2: REMIND LATER



If you press **REMIND LATER**, the message will repeat 24 hours later.

### 10.2 Preventative Maintenance Schedule

#### What you should do

##### Daily

Wipe the door gasket clean with a damp, lint-free cloth.

Clean external surfaces with a damp, lint-free cloth.

##### Weekly

Clean the chamber and, if applicable, the waste bottle.

Disinfect external surfaces.

##### Monthly or every 100 cycles

Drain and clean both water reservoirs and water reservoir filters.

Inspect and clean the 3 chamber filters.

Clean the external distilled water tank - if installed.

Clean the chamber rack and trays.

##### Every 6 months or 500 cycles

Perform all the cleaning tasks listed in the monthly schedule (above).

##### (Message appears at these intervals)

Replace the bacteriological filter.

Replace the door seal.

#### What the technician should do

##### Every year or 1,000 cycles

A complete maintenance and calibration of the autoclave (by a SciCan-approved technician) is recommended.

## 10.3 Cleaning the Door Seal and Door Plate

Frequency: Daily

1. Using a clean cloth dampened with water, wipe the door seal and door plate. Dry.

### CAUTION! Hot Chamber.

The unit's Stand-by mode is preset to maintain a hot chamber. Turn the unit off and allow adequate time for it to cool before performing maintenance.

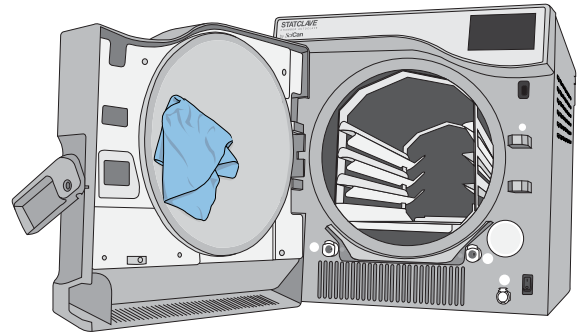

## 10.4 Cleaning the Sterilization Chamber, Rack and Trays

Frequency: Monthly or every 100 cycles

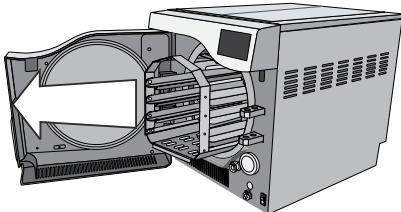
1.  Remove the sterilization trays and the rack from the chamber. (Pull the rack out to disengage it)

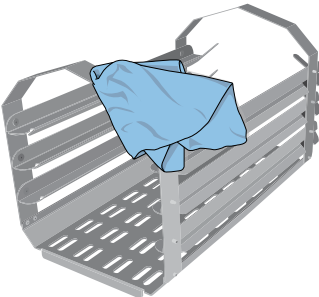
3.  Use a clean cloth dampened with water to clean the STATCLAVE rack and trays.

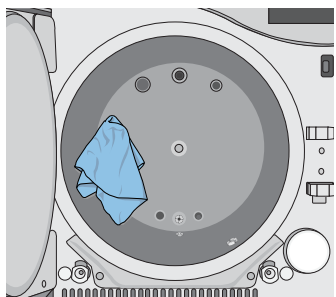
2.  Use a clean cloth dampened with water to clean the chamber and the chamber flange. Wipe dry.

### CAUTION! Hot Chamber.

The unit's Stand-by mode is preset to maintain a hot chamber. Turn the unit off and allow adequate time for it to cool before performing maintenance.

**IMPORTANT!** When cleaning the chamber, be careful not to damage the temperature probe on the inside back wall of the chamber.

## 10.5 Cleaning and Disinfecting the External Surfaces

Frequency: Clean daily. Disinfect weekly.

1. Clean all of the STATCLAVE's external parts using OPTIM wipes or a clean cloth dampened with water and, if needed, a mild detergent.
2. Dry the surfaces and remove any residue before powering ON the unit.

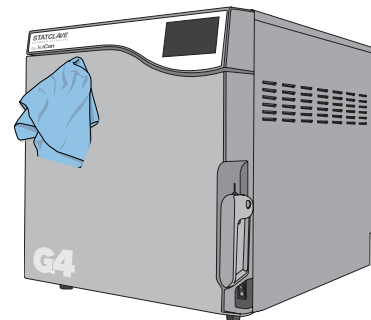



## 10.6 Draining the Reservoirs for Cleaning and Shipping

**IMPORTANT!** Before shipping or servicing the unit, drain all water from the unit using these 3 ports.

Use the waste bottle or arrange an empty 4-litre (1 gallon) container on the floor near the autoclave and insert the free end of the silicone drain tube (supplied with your STATCLAVE).

### To drain CLEAN WATER reservoir:

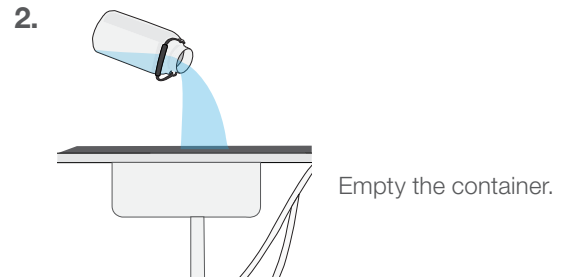
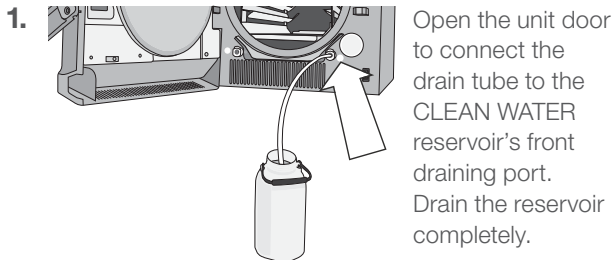

### To drain WASTEWATER reservoir:

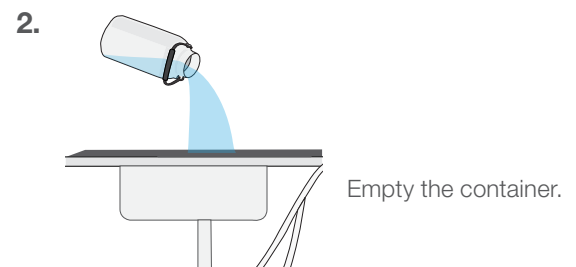
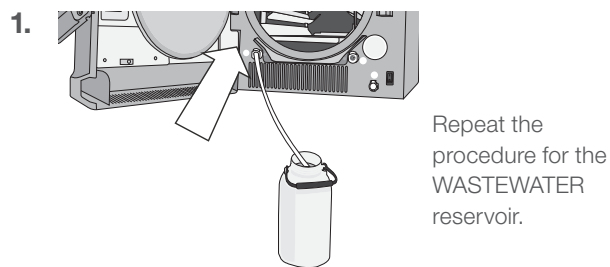

## 10.7 Cleaning the Water Reservoirs and Reservoir Filters

**Frequency: Monthly or every 100 cycles.**

To avoid accidental cross-contamination, always start with the clean water reservoir and complete steps 1-4 BEFORE cleaning the Venturi reservoir.

Follow the draining instructions in Section 10.6 to drain the reservoir completely.

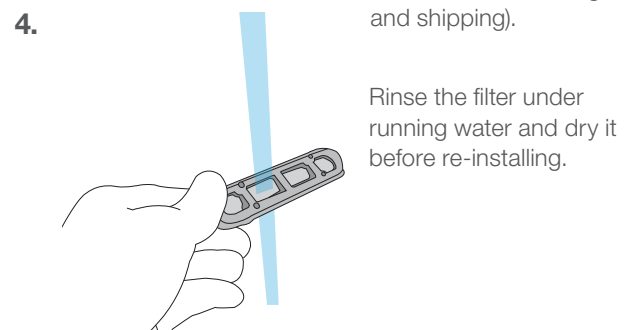
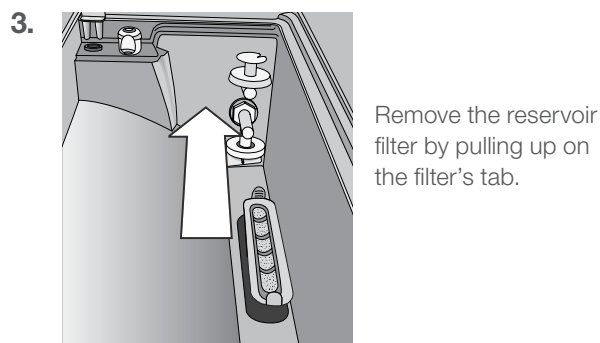
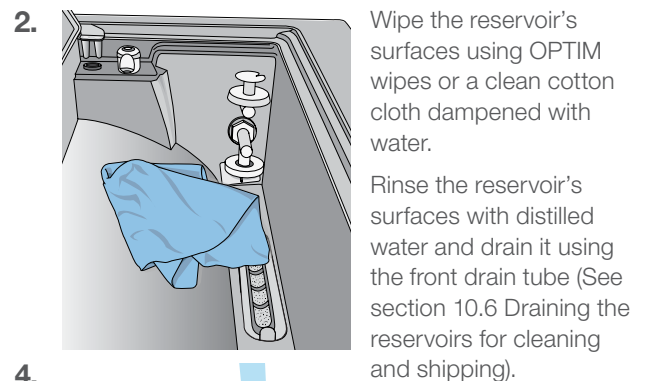
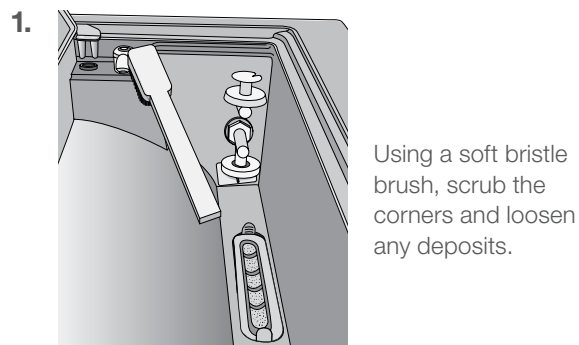

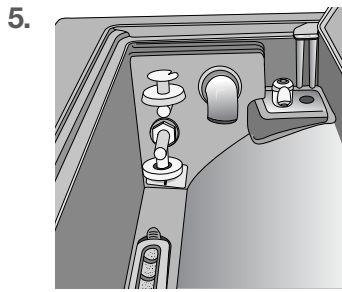

Repeat these steps to clean the Venturi reservoir.

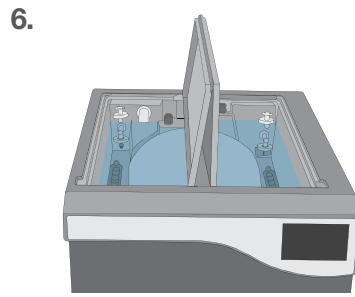

Once you have cleaned both reservoirs, fill them with distilled water and run one empty cycle.

**CAUTION!**

To avoid cross contamination, be sure to use a different cloth and container with solution to wipe the internal surfaces of each reservoir.

## 10.8 Cleaning the External Distilled Water Tank

**Frequency: Monthly or every 100 cycles.**

1. Disconnect the external tank from the autoclave and close the tank valve.
2. Fill the tank with a solution of distilled water and alcohol (10%), such as isopropyl.
3. Allow the solution to sit for 30 minutes.
4. Drain the tank and discard the solution.
5. Fill the tank with water and drain it to remove any residual alcohol solution.
6. Reconnect the tank to the autoclave and refill it with distilled water.

## 10.9 Cleaning the Chamber Filters

**CAUTION! Hot Chamber.**

The unit's Stand-by mode is preset to maintain a hot chamber. Turn the unit off and allow adequate time for it to cool before performing maintenance.

**Frequency: Monthly or every 100 cycles.**

Over time, the chamber's three filters will collect enough debris to slow chamber draining and effect performance. To clean or replace the filters follow these steps:

1. Remove the 3 chamber filters by unscrewing them from the chamber. Clean each filter under running water to clear the mesh of debris. (If the filter cannot be reused, replace it).
2. To reinstall a filter, screw the filter back into position, hand tight.

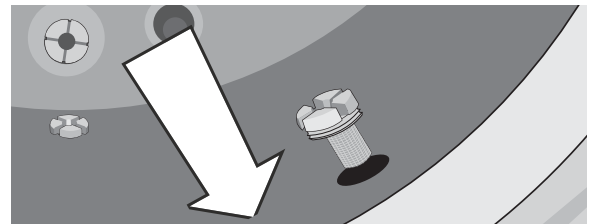
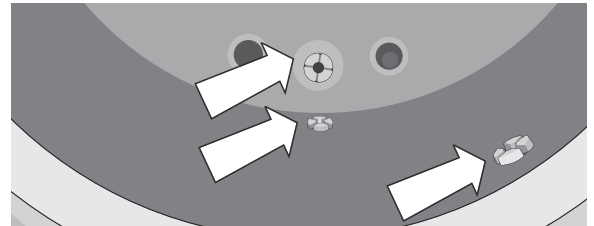

## 10.10 Replacing the Bacteriological Filter

Frequency: Every 6 months or 500 cycles.

1. Open the unit door.
2. Unscrew the bacteriological filter.
3. Replace it with a new filter, hand tighten.

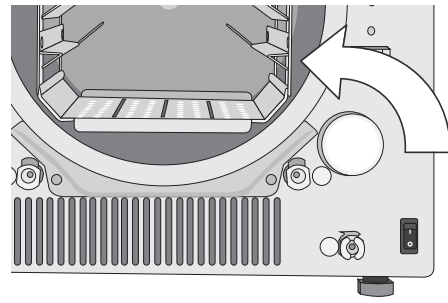

### CAUTION!

A bacteriological filter must always be in place during a cycle. Running a cycle without a bacteriological filter in place will compromise the sterility of the load.

## 10.11 Replacing the Door Seal

### CAUTION! Hot Chamber.

The unit's Stand-by mode is preset to maintain a hot chamber. Turn the unit off and allow adequate time for it to cool before performing maintenance.

Frequency: Every 6 months or 500 cycles.

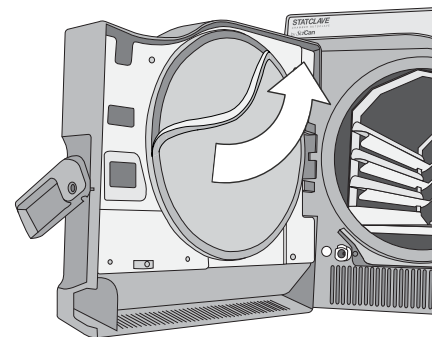

1. Remove the old gasket by pulling it out of position. Clean the door gasket seat of any debris.

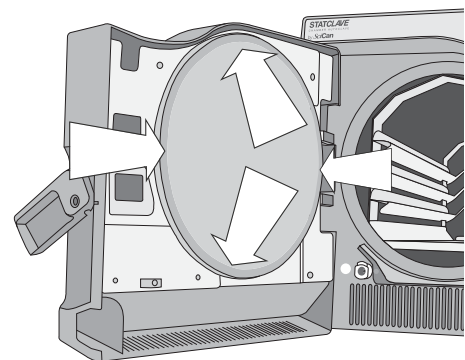

2. Put the new door gasket in place and press the gasket into its seat. Start at the top, then bottom, then sides. With four sides seated, push the remaining gasket completely into its seat.



## 10.12 Using on-Screen Instructions

The STATCLAVE on-screen help instruction can be found in the Setup menu. From the Home screen, select  then  and follow these steps:

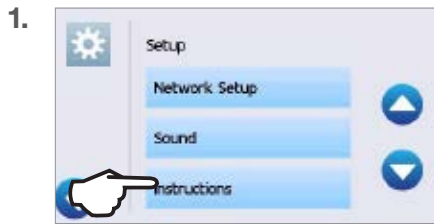

Press on the instructions you would like to view.





Use the **PAUSE** icon to stop on any image of the sequence being presented.



To **EXIT** press anywhere on the image.

## 10.13 Enabling a Technician to Access Your STATCLAVE from a Remote Location

Technicians and other authorized personnel may want to connect to your STATCLAVE from a remote location to review its functioning or access stored information. To allow an external user to remotely access your STATCLAVE, you will need to provide a security token to the person requesting access.

To obtain this code, from the home screen, select  then  and follow these steps:

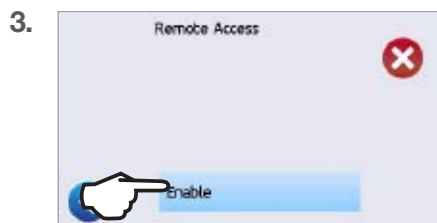
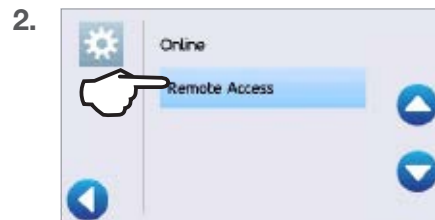

Press **ENABLE** and wait a few seconds for a security token to be provided.

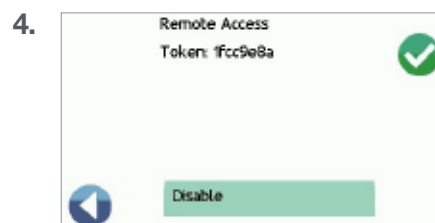

Provide the token number to the technician requiring Remote Access.

**DON'T** press **DISABLE** until the session is complete or until otherwise instructed.

The token is valid for 2 hours after which the remote session automatically disconnects. To end the session earlier, select **DISABLE** from the Remote Access screen to disable the token.



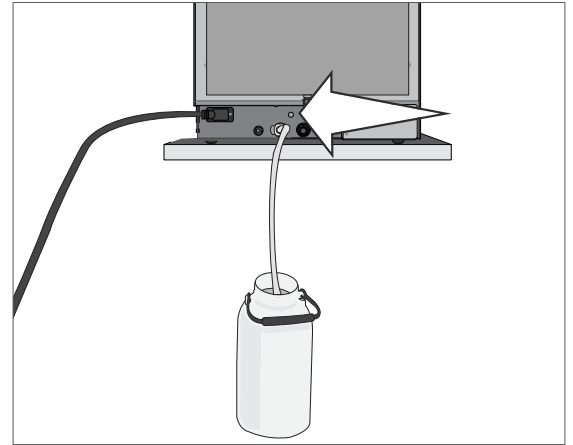

## 10.14 Preparing the Unit for Shipping

Most of the water can be drained from the system using the reservoir draining procedure described in *Section 10.6 Draining the Reservoirs for Cleaning*. In addition, the back panel condenser must also be drained.

**To drain the Condenser:** Access the back of the unit to insert the quick-connect drain tube into the condenser draining port.



# 11. Troubleshooting

Problem	Possible Cause	Possible Solution
Unit does not power ON.	Power cord or main power issue	Check that the unit is plugged into a properly grounded outlet and that the power cord is firmly seated at the rear of the machine. Try another circuit. Power unit OFF for 10 seconds and then power ON again.
There is water under the machine.	Spill over from filling External water tank feed issue	Check that water was not spilled when filling the reservoir. Check that the tube coming from the external tank (if fitted) is completely pushed into the clean water fill port. Run a Vacuum Test. If water drips from the underside of the unit during the test, call your SciCan dealer.
Instruments do not dry.	Improper loading Wrong cycle selection for this particular load Chamber draining issues	For optimal drying, allow the cycle to continue to completion. Make sure the instruments are loaded correctly in the chamber. Refer to Section 5. Loading Instruments. Chamber filters are blocked. See Section 10.9 Cleaning the Chamber Filters.
Cycle interrupted – NOT STERILE, Cycle aborted – NOT STERILE and CYCLE FAULT messages.	The STOP button was pressed while the unit was in operation. A power outage or power fluctuation occurred while the unit was in operation.	Wait a few minutes and try to run a cycle again before proceeding to the next solution. NOTE: STATCLAVE units connected to the Internet and registered with SciCan will automatically send Cycle Fault messages to SciCan's international service center.
Excessive steam coming from the front of the machine.	Door seal issue	Open and close the door then try to run a cycle again. Check the door seal for misalignment or damage. Replace the door seal if required. See Section 10.11 Replacing the Door Seal. If the leak persists, turn the unit OFF, remove the load and contact your SciCan dealer.
Machine will not start and touchscreen shows  next to:	 Clean water level low	If water level is too low: Refill the reservoir. Check that the water level sensor floats freely. Refer to the steps described in Section 4. Filling the Water Reservoirs.
	 There is a water quality problem. Press icon to view detail.	If the water quality is inadequate, you have likely used water that is not steam-process distilled or is improperly distilled. Empty the reservoir and refill with steam-process distilled water containing 6.4 ppm or less of total dissolved solids (having conductivity of 10 µS/cm or less).
	 Venturi water level low.	Check that the water level sensor floats freely. Refer to the steps described in Section 4. Filling the Water Reservoirs.
	 There is a problem locking the door.	Check for instruments jamming the door. Check the door seal for obstructions.

Problem	Possible Cause	Possible Solution
<b>Time and date are incorrect.</b>	Unit was shipped to a new time zone.	The time and date are set on the date of manufacture but have not been adjusted for a new time zone. See Section 8. Using and Changing your STATCLAVE's Settings.
<b>USB storage device does not contain the last print out</b>	USB device failure	Re-insert the USB storage device and wait for the data to copy over again. If the problem persists, back up all the information you have on the USB device and reformat it. NOTE: You can always access all of your unit's cycle information through the unit's web portal. See Section 9. Storing, Retrieving and Printing Sterilization Records.
<b>Touchscreen shows:</b> 	Unit is not connected to Internet	A red X over the connectivity icon means the unit is not connected to a network. If it is supposed to be connected to a network and the X is visible, it is because the unit is unable to acquire an IP address. To resolve the issue, try some of the following: Check that the router is functioning properly Check the LAN cable (try a new cable if possible) Make sure your router assigns IP addresses automatically. Renew the IP address by following these steps: Scroll through the USER menu to NETWORK SETUP and select. Select RENEW IP.
<b>Unit's total cycle time is too long</b>	Unit is starting with a cold chamber	From a cold start, the unit's total cycle time can take as much as 12 additional minutes. Reduce the warm-up time between cycles or set the unit to warm-up at a specific time in the morning. See Section 8.3 Setting the Stand-by Mode.
	Chamber filters are clogged.	Debris in the chamber filters can have an affect on cycle times. Remove the chamber rack and inspect the chamber filters. Clean as necessary. See Section 10.9 Cleaning the Chamber Filters.
<b>Door will not open – no power</b>	Power failure	Use Emergency Door Unlocking procedure. See Section 6.4 Emergency Door Opening.
<b>Door will not open - power</b>	Lock is still engaged	Press the flashing yellow lock icon to go to the door lock status screen and press the unlock icon. See Section 1.7 Unlocking the Door. This screen will show if the chamber is under pressure or vacuum and whether it can be opened. See Section 6.2 Stopping a Cycle.
<b>Instruments are blackening or there is damage to materials.</b>	Sterilization temperature is too high for the materials	The sterilization program selected is not appropriate for the materials/instruments being sterilized. Check materials/instruments manufacturer's recommendations. Also see Section 7. Sterilization Programs.
<b>Water remains in the chamber at the end of a cycle</b>	Chamber filters are obstructed	Inspect the four chamber filters and clean or replace them as needed. See Section 10.9 Cleaning the Chamber Filters.
	Drying time is too short	Drying times can be adjusted. See Section 8.2 Setting Drying Time.

<b>Problem</b>	<b>Possible Cause</b>	<b>Possible Solution</b>
<b>Instruments show traces of oxidation or spotting</b>	Low quality instruments	Instruments made of inferior materials can be prone to discoloration. Check the quality of the instruments that are spotting. Verify that they can tolerate steam sterilization as per the instrument manufacturer's instructions for use.
	Organic or inorganic residues on the instruments	Instruments must be free of debris prior to sterilization. Clean and rinse all instruments before loading them into the autoclave. Disinfectant residues and solid debris may inhibit sterilization and damage the instruments and the STATCLAVE G4. Lubricated instruments must be wiped thoroughly and any excess lubricant should be removed before loading.
	Contact between instruments made of different metals	Separate instruments made of different metals. See Section 5.3 Unwrapped Instruments for instructions on arranging instruments made of different materials.
<b>Vacuum test has failed</b>	The unit chamber was hot when the test was initiated	Ensure Stand-by chamber warming system is turned OFF. (See Section 8.3 Setting the Stand-by Mode). Make sure the chamber is cooled to room temperature before attempting a second Vacuum Test. If subsequent Vacuum tests consistently fail, contact your SciCan dealer.
<b>Bowie-Dick test has failed</b>		Attempt a second Bowie-Dick test. If the second test fails, contact your SciCan dealer.
<b>Water in the chamber</b>	Cycle interrupted during warm-up phase	Remove load. Remove rack. Use clean cloth or paper towel to mop up excess water. Insert rack and load and start a new cycle.
<b>Unit is using too much water</b>	Unit is overloaded	See Section 5. Loading Instruments for details on load capacities.
<b>No cycles are stored in the unit's memory</b>	Logic board configuration issue	Check the unit's serial number to see if it was accurately updated after a logic board service. If number consists entirely of zeros, call SciCan.
<b>Door will not close</b>	Item obstruction	Check for an instrument or a cassette that is keeping the door from closing correctly. Check the door seal to make sure it is properly seated. To re-seat the door seal, see Section 10.11 Replacing the Door Seal.
<b>Door will not close - No obstructions</b>	Chamber pressure balance issue.	Leave the door open for 1 minute and try again.
<b>Handle in closed position but door not showing 'locked'</b>	The door will lock once cycle is initiated.	Press the START button to initiate the door lock microswitch.



Error Code	Possible Cause	What you can check before calling for service
CF 4	Door seal leak.	<p>Check door seal for obstructions.</p> <p>Check that the door seal is properly seated in the door channel.</p> <p><b>CAUTION! Surfaces may be hot.</b></p>
CF 10	Blocked exhaust.	<p>Check the exhaust tubing at the back of the unit to make sure it is not blocked or kinked.</p> <p>Check that the exhaust tubing does not have a deep sag that could impede the flow of exhaust water.</p> <p><b>CAUTION! Surfaces may be hot.</b></p>
CF 16	Steam generator is too hot.	<p>Check that the water levels in both reservoirs are adequate. (See <i>Section 4 Filling the Water Reservoirs</i>).</p>
CF 17	Initial vacuum phase unsuccessful.	<p>Check door seal for obstructions.</p> <p>Check that the door seal is properly seated in the door channel.</p> <p><b>CAUTION! Surfaces may be hot.</b></p>
CF 43	Problem with the automatic clean water filling system.	<p>Check the auxiliary pump to see that it is correctly connected. (See <i>Section 4.4 Automatic Filling Using External Water Tank and Auxiliary Pump</i>).</p> <p>Check if the unit is set to automatic filling but there is no pump connected. (See <i>Section 4 Filling the Water Reservoirs</i>).</p> <p>Check for a blocked or kinked filling tube.</p> <p><b>CAUTION! Surfaces may be hot.</b></p>
CF 44	Venturi reservoir is too full.	<p>Check for a blocked exhaust tube.</p> <p>Check the Venturi reservoir overflow sensor (the float sensors on the back wall of the reservoir) to make sure it is not simply stuck in the high position.</p> <p>Sometimes the overflow sensor is unintentionally activated during a reservoir cleaning. This can prompt a CF 44 message. Press the STOP icon to reset.</p> <p><b>CAUTION! Surfaces may be hot.</b></p>
CF 73	Unable to reach vacuum.	<p>Check door seal for obstructions.</p> <p>Check that the door seal is properly seated in the door channel.</p> <p><b>CAUTION! Surfaces may be hot.</b></p>
CF 77	Unable to reach vacuum.	<p>Check door seal for obstructions.</p> <p>Check that the door seal is properly seated in the door channel.</p> <p><b>CAUTION! Surfaces may be hot.</b></p>

## 12. Ordering Spare Parts and Accessories

Spare Parts	
01-115481S	Door Seal, STATCLAVE G4
01-115479S	Bacteriological Air Filter
01-115478S	Chamber Filter Kit (3 filters)
01-115487S	Chamber Rack
01-115482S	Mesh Trays (1 pc)
01-115483S	Pouch Rack (1 pc)
01-115485S	Tray Extractor with Door Unlock Pin (in handle)
01-115484S	Drying plate (1 pc)
01-115488S	Drain tube with quick-connect to drain reservoirs
01-115480S	Filter for reservoirs (1)
01-115486S	Mounting feet, fixed and adjustable (4 pcs)
01-115489S	Drain bottle kit
01-115490S	Exhaust tubes - 13 ft/4 m length (2 pcs)
01-115491S	Power cord N.A. 15A/125V
USB-STICK2	USB memory stick
Accessories	
01-115375	Direct-to-Drain Kit
01-115554	Direct-to-drain kit Teflon
01-115373	Manual fill container with quick connect tubing for front fill option
01-115374	Automatic fill pump, 1.5 m cord
01-115631	Automatic fill pump, 2.5 m cord

## 13. Warranty

### Limited Warranty

For a period of two years or 2500 cycles, which ever appears first, SciCan guarantees that the STATCLAVE G4 Autoclave, when manufactured by SciCan in new and unused condition, will not fail during normal service due to defects in material and workmanship that are not due to apparent abuse, misuse, or accident.

The two year warranty will cover the performance of all components of the unit except consumables such as the door seal, bacteriological filter, chamber filters, wire racks and trays, provided that the product is being used and maintained according to the description in the operator's manual.

In the event of failure due to a component defect during this period of time, the exclusive remedies shall be repaired or replaced, at SciCan's option and without charge, of any defective non-consumable part(s) (except gasket), provided SciCan is notified in writing within thirty (30) days of the date of such a failure and further provided that the defective part(s) are returned to SciCan, prepaid.

This warranty shall be considered to be validated if the product is accompanied by the original purchase invoice from the authorized SciCan dealer, and such invoice identifies the item by serial number and clearly states the date of purchase. No other validation is acceptable.

After two years or 2500 cycles, all SciCan's warranties and other duties with respect to the quality of the product shall be conclusively presumed to have been satisfied. All liability therefore shall be terminated, and no action or breach of any such warranty or duty may thereafter be commenced against SciCan.

Any express warranty not provided hereon and any implied warranty or representation as to performance, and any remedy for breach of contract which, but for this provision, might arise by implication, operation of law, custom or trade or course of dealing, including any implied warranty of merchantability or of fitness for particular purpose with respect to all and any products manufactured by SciCan is excluded and disclaimed by SciCan.

If you would like to learn more about SciCan products and features or to register your warranty online, visit our website at [www.scican.com](http://www.scican.com).

## 14. Specifications

<b>Machine Dimensions:</b>	Width: 17.75" / 450 mm Height: 19-19.5" / 483-495 mm Depth: 25" / 635 mm
<b>Chamber Dimensions:</b>	Diameter: 11" / 280 mm Depth: 15" / 381 mm
<b>Sterilization Chamber Volume:</b>	7 US gal / 26 L
<b>Distilled Water Reservoir Volume:</b>	1 US gal / 4 L
<b>Venturi Reservoir Volume (with condenser full):</b>	1.6 US gal / 6 L
<b>Weight (without water):</b>	136 lbs / 61.7kg
<b>Weight (with full reservoirs and full load):</b>	175 lbs / 79.5kg
<b>Clearance required:</b>	Top: 7" / 180 mm Right Side: 2" / 50 mm Left Side: 0" / 0 cm Front (to open door): 16" / 410 mm Back: 0" / 0 mm
<b>Water quality:</b>	≤ 6.4 ppm / 10 μS/cm (conductivity at 25°C / 77°F)
<b>Minimum distilled water volume required for cycle:</b>	0.26 US gal / 1 L
<b>Minimum wastewater volume required for cycle:</b>	0.26 US gal / 1 L
<b>PRV value (pressure relief valve):</b>	Set at 40.6 PSIG / 2.8 bar gauge to release pressure in overpressure situations
<b>Electrical Rating:</b>	120V, 60Hz, 12 A
<b>Ethernet Port:</b>	10/100 Base-T
<b>USB Port:</b>	USB 2.0
<b>Current:</b>	AC
<b>Protection Class:</b>	I
<b>Protection:</b>	covered
<b>Ambient Operating Temperature:</b>	5°C - 40°C / 41°F - 104 °F
<b>Sound levels:</b>	≤ 60 dB
<b>Humidity:</b>	80% Maximum
<b>Maximum Altitude:</b>	2000 m / 6562 ft

# APPENDIX A

## Software Icons



### Network connection



No Internet or network connection. Press to view detail.



Network but no Internet connection. Press to view detail.



Network and Internet connected. Press to view detail.



### USB icon variations:



USB key not inserted.



USB key inserted.



USB engaged and recording cycle information. Do not remove.



### Door Lock icon variations:



Door is unlocked.



Door is locked. PRESS to unlock.



### Settings



PRESS to access Settings menu.

# APPENDIX B

## Software Screens



**Connectivity screen:** PRESS to access network and Internet information

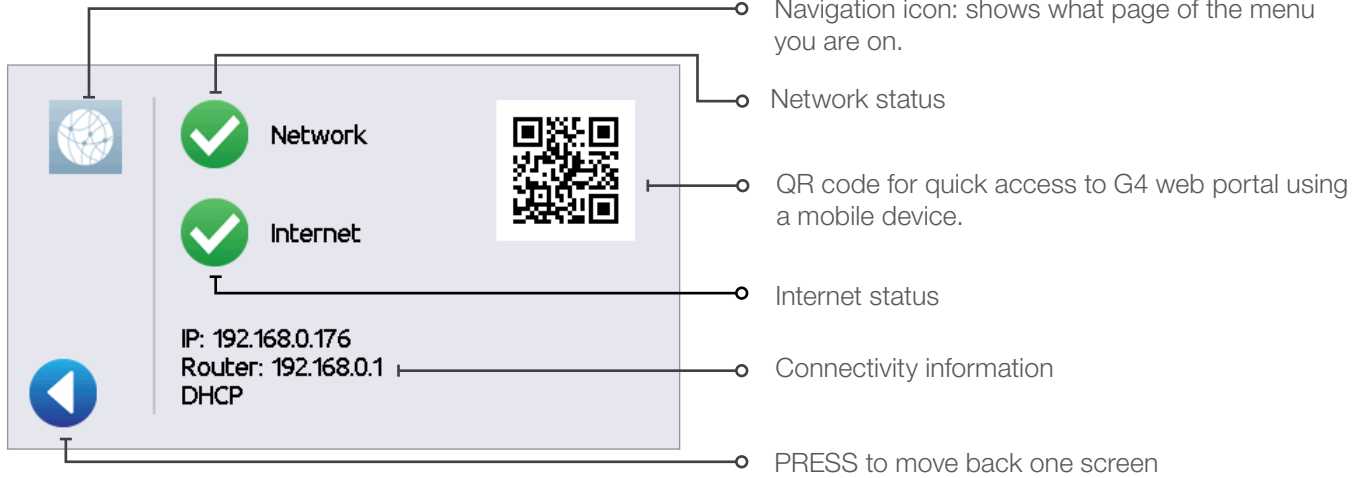

**USB screen:** PRESS to view cycle history

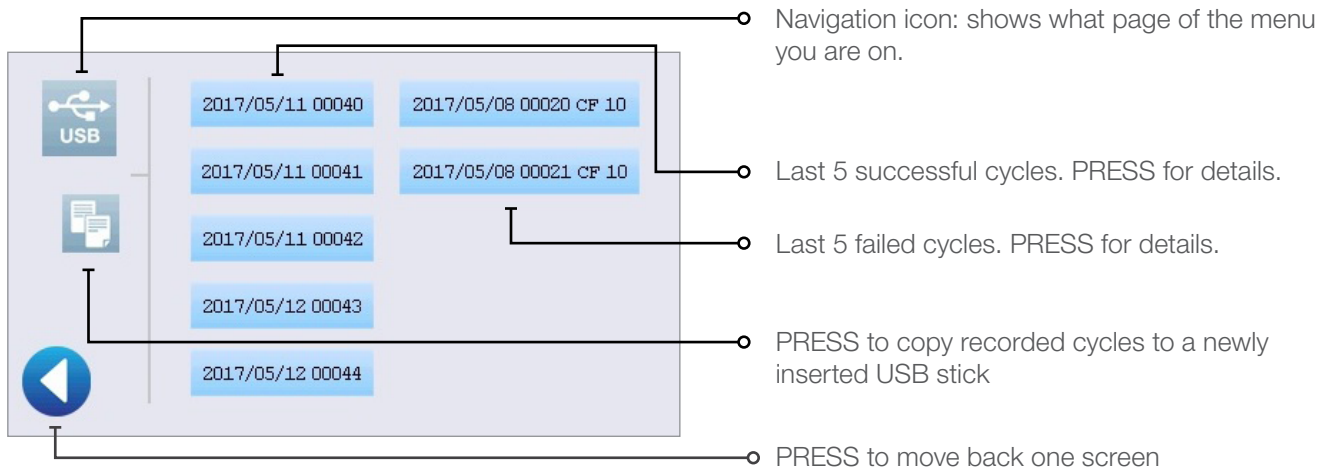





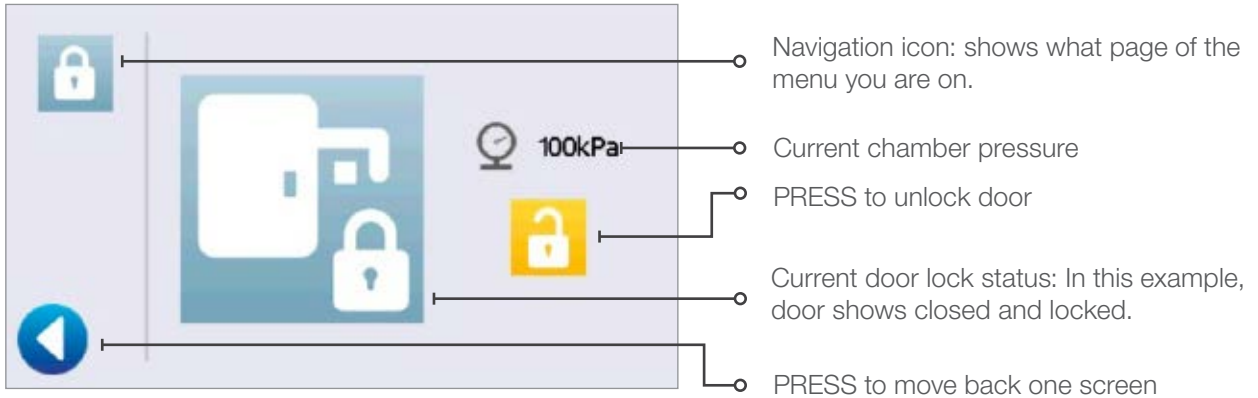

# APPENDIX B

 **Door lock screen:** PRESS to view door and lock status.



## Door lock breakdown:

	Door CLOSED, not latched		Door OPEN
	Door CLOSED and LOCKED		Chamber pressure is out of range. Door cannot be unlocked at this time.
	Door CLOSED and UNLOCKED		PRESS icon to unlock door.

 **Settings screen:** PRESS to access settings

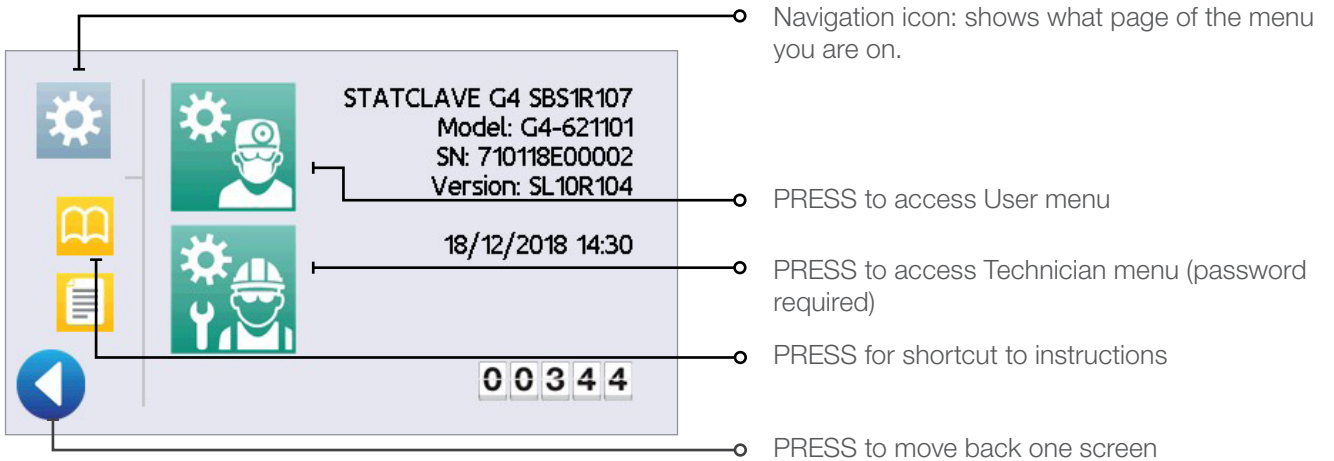

PRESS to update cycle data with indicator results.

# APPENDIX C

## STATCLAVE Cybersecurity Statement

A network disruption or cybersecurity incident will not prevent this device from performing its primary function of completing a sterilization cycle. Additionally, a cybersecurity incident affecting the device cannot result in direct patient harm since the device does not come into contact with a patient. While the unit records, stores and sends (if connected to a network) information about a cycle, no patient data is stored on the unit.

The unit's functionality and design observe a number of additional cybersecurity risk mitigation measures:

- › Prevents unauthorized access to safety-critical settings.
- › Ensures trusted content by maintaining code, data and execution integrity.
- › Recovers capabilities or services that were impaired due to the cybersecurity incident.
- › Authentication methods and controls are used for each part of the communicating assets such as web sites, servers, interoperable systems and cloud storage.

### Addressing STATCLAVE Cybersecurity Vulnerabilities

STATCLAVE Item	CBOM Item	National Vulnerability Database Reference	Control / Rationale
Microcontroller logic board	Vybrid VF6xx	CVE-2017-7936	-SDP protocol redirected to UART 3 and pins are not available (not connected)
		ERR010872 – Secure Boot Vulnerability when using the Serial Downloader (CVE-2017-7936)	-SDP protocol available to USB0. Connection not available outside of the PCB. Physical access to logic board required in order access USB0 OTG port (physical locks in place).
Microcontroller logic board	Vybrid VF6xx	CVE-2017-7932 ERR010873 – Secure Boot Vulnerability when Authenticating a Certificate (CVE-2017-7932)	-SDP protocol redirected to UART 3 and pins are not available (not connected) -SDP protocol available to USB0. Connection not available outside of the PCB. Physical access to logic board required in order access USB0 OTG port (physical locks in place)
Operating system	MQX 4.2	ICSA-17-285-04A Classic Buffer Overflow, Out-of-Bounds Read	Patched DHCP client to address the buffer overflow
SSL stack	WolfSSL 3.14	CVE-2018-12436 (ROHNP)	Does not apply as attacker is required to run code on the same host (embedded platform) where the Wolfssl library is running. Embedded platform does not allow running of unauthorized code.
WiFi module	GS2011MIE	n/a	n/a