

## WASHER DISINFECTOR TIVA8-MD

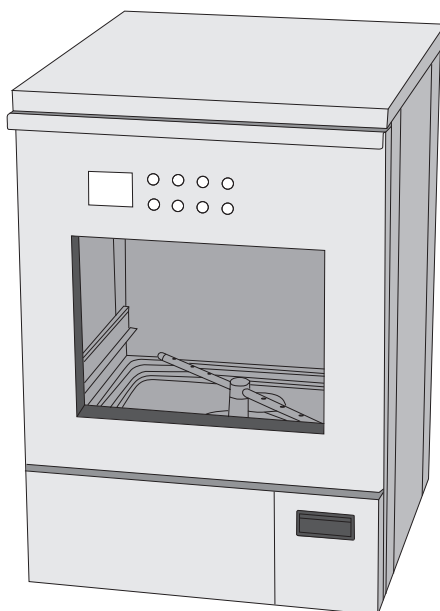

## INSTRUCTIONS FOR USE



Before starting to operate with  
the washer disinfector, read  
these instructions for use

Original instructions  
Code Man205-0745009EN - Rev. 02  
Edit. 06-2022  
Language: English  
Firmware version: 00B03

## TRANSCRIBE THE MACHINE DATA

MODEL: \_\_\_\_\_

SERIAL NUMBER: \_\_\_\_\_

YEAR OF MANUFACTURE: \_\_\_\_\_

THIS DATA MUST ALWAYS BE QUOTED WHEN REQUESTING ASSISTANCE AND/OR SPARE PARTS TO THE MANUFACTURER.

---

### MANUFACTURER:

**TUTTNAUER LTD. HAR-TUV B INDUSTRIAL ZONE  
P.O BOX 170 BEIT SHEMESH 9910101, ISRAEL  
TEL. 972 2 9904611 - FAX 972 2 9904700**

**US OFFICE: TUTTNAUER USA Co.LTD.  
25 POWER DRIVE HAUPPAUGE, N.Y. 11788, USA  
TEL. +1 631 737 48 50 / +1 800 624 58 36 - FAX +1 631 737 07 20  
WEB: [WWW.TUTTNAUERUSA.COM](http://WWW.TUTTNAUERUSA.COM)**

**MODELS COVERED BY THE MANUAL:  
TIVA8-MD**

---

## WARNING

IT IS STRICTLY FORBIDDEN TO USE THE MACHINE BEFORE HAVING READ AND UNDERSTOOD THIS MANUAL.

THE MANUFACTURER DECLINES ALL AND ANY LIABILITY FOR DAMAGE DUE TO NEGLIGENCE AND FAILURE TO COMPLY WITH THIS MANUAL AND IS ALSO NOT LIABLE FOR ANY DAMAGE CAUSED BY INCORRECT INTERPRETATIONS OF THE INSTRUCTIONS CONTAINED.

CHECK FOR ANY UPDATES TO THIS MANUAL ON THE MANUFACTURER'S WEBSITE.

# INDEX

<b>1 SYMBOLS USED IN THE MANUAL</b> . . . . .	<b>4</b>
<b>2 PRESENTATION</b> . . . . .	<b>4</b>
2.1 FIELD OF APPLICATION . . . . .	5
2.1.1 INTENDED USE . . . . .	5
2.1.2 INTENDED USERS . . . . .	5
2.1.3 INTENDED USE OF ENVIRONMENT . . . . .	5
2.2 LABEL SPECIFICATIONS . . . . .	5
2.3 WARRANTY . . . . .	5
2.4 WARRANTY EXCLUSIONS . . . . .	6
2.5 PRODUCT ANALYSIS . . . . .	7
2.5.1 INLET WATER QUALITY . . . . .	7
2.6 TECHNICAL DATA . . . . .	8
2.6.1 MAIN COMPONENTS OF THE MACHINE . . . . .	8
2.7 ACCESSORIES . . . . .	9
2.8 MACHINE STAND . . . . .	10
<b>3 SAFETY AND PREVENTION</b> . . . . .	<b>10</b>
3.1 GENERAL WARNINGS . . . . .	10
3.1.1 USER OBLIGATIONS . . . . .	10
3.1.2 INSTALLER OBLIGATIONS . . . . .	10
3.1.3 OPERATOR OBLIGATIONS . . . . .	10
3.1.4 MAINTENANCE SERVICE PERSONNEL OBLIGATIONS . . . . .	11
<b>4 HANDLING</b> . . . . .	<b>11</b>
4.1 STORAGE . . . . .	13
<b>5 INSTALLATION</b> . . . . .	<b>13</b>
5.1 UNDER THE COUNTER INSTALLATION . . . . .	14
5.2 ELECTRICAL CONNECTION . . . . .	14
5.2.1 ELECTRICAL CONNECTION . . . . .	15
5.3 WATER CONNECTION . . . . .	15
5.3.1 ACQUASTOP SYSTEM . . . . .	17
5.3.2 MODELS WITH BUILT-IN WATER SOFTENER . . . . .	17
5.3.3 REGENERATION SALT . . . . .	17
5.3.4 SALT REFILL . . . . .	17
5.3.5 AUTOMATIC REGENERATION . . . . .	18
5.4 CONNECTION OF THE DRAIN TRAP . . . . .	18
5.4.1 DRAIN CONNECTION . . . . .	19
5.4.2 WASTE HOSES . . . . .	19
5.4.3 CONNECTION POINT FOR WASTE . . . . .	19
5.5 FILTERS AND SPRAY ARMS . . . . .	19
5.5.1 CHAMBER FILTERS . . . . .	19
5.5.2 SPRAY ARMS . . . . .	19
5.6 CHEMICALS . . . . .	20
5.6.1 REFILL PROCEDURE . . . . .	20
5.6.2 USING AND STORING CHEMICALS . . . . .	20
<b>6 USING THE MACHINE</b> . . . . .	<b>21</b>
6.1 COMMISSIONING INSTRUCTIONS . . . . .	21
6.1.1 LOADING THE CHEMICALS . . . . .	21
6.2 BEFORE USE . . . . .	22
6.2.1 EMERGENCY DOOR RELEASE . . . . .	22
6.2.2 PREPARING THE LOAD . . . . .	22
6.2.3 SUMMARY OF THE RACK LOADING OPERATIONS . . . . .	23
6.2.4 TREATMENT OF DENTAL INSTRUMENTS . . . . .	23
6.2.5 TREATMENT OF OPHTHALMIC INSTRUMENTS . . . . .	24
6.3 PROGRAMS . . . . .	24
6.3.1 SUGGESTED PROGRAMS VS CONFIGURATIONS . . . . .	24
6.3.2 PROGRAM STRUCTURE . . . . .	24
6.4 STARTING THE MACHINE . . . . .	24
6.4.1 BEFORE STARTING THE PROGRAM . . . . .	24
6.4.2 STARTING THE PROGRAM . . . . .	25
6.4.3 PROGRAM END . . . . .	25
6.4.4 EXTRACTING THE LOAD . . . . .	26
<b>7 CONTROL PANEL</b> . . . . .	<b>26</b>
7.1 COLORS OF THE KEYS . . . . .	27
7.2 DISPLAY . . . . .	27
7.2.1 MESSAGES ON THE DISPLAY . . . . .	27
7.2.2 BLUETOOTH ENABLED . . . . .	27
7.2.3 DISPLAY SCREENS . . . . .	28
7.2.4 PROGRAM 2 REGULAR . . . . .	29
7.2.5 ALARM MESSAGES . . . . .	32
7.2.6 USER SETTINGS MENU . . . . .	32
7.2.7 SETTINGS . . . . .	33
7.2.8 LANGUAGE SETUP . . . . .	33
7.2.9 USB KEY MANAGEMENT . . . . .	33
7.2.10 PROCEDURE FOR PASSWORD CHANGE . . . . .	34
7.2.11 EXPIRING PASSWORDS . . . . .	34
7.3 ALARMS . . . . .	34
7.4 WARNINGS . . . . .	34
<b>8 SOFTWARE DESKTOP</b> . . . . .	<b>34</b>
8.1 GENERAL INFORMATIONS . . . . .	34
8.2 BLUETOOTH . . . . .	34
<b>9 PLUGS</b> . . . . .	<b>35</b>
9.1 USB PLUGS . . . . .	35
9.2 RS232 PORT . . . . .	35
9.2.1 LAN NETWORK COMMUNICATION VIA RS232 . . . . .	35
<b>10 LOADING THE PRINTER PAPER ROLL</b> . . . . .	<b>36</b>
<b>11 MAINTENANCE</b> . . . . .	<b>36</b>
11.1 GENERAL INFORMATION . . . . .	36
11.1.1 PERIODIC MAINTENANCE REQUEST . . . . .	36
11.1.2 PERSONAL PROTECTIVE EQUIPMENT (PPE) . . . . .	37
11.1.3 CLEANING PRODUCTS . . . . .	37
11.2 ROUTINE MAINTENANCE . . . . .	37
11.2.1 CLEANING THE CHAMBER FILTERS . . . . .	37
11.2.2 CLEANING THE SPRAY ARMS . . . . .	37
11.2.3 CLEANING THE AIR SUCTION FILTER . . . . .	38
11.2.4 REPLACING THE AIR SUCTION FILTER . . . . .	38
11.3 SPECIAL MAINTENANCE . . . . .	38
11.4 TROUBLESHOOTING . . . . .	38
11.5 EQUIPMENT DISPOSAL . . . . .	39
11.6 SPARE PARTS . . . . .	39
<b>12 ANNEXES</b> . . . . .	<b>40</b>
12.1 MENU PARAMETER TABLE . . . . .	40
12.2 MENU STRUCTURE . . . . .	44
12.3 PROCEDURE FOR PASSWORD CHANGE . . . . .	45
12.4 PROCEDURE FOR USER PASSWORD SETUP FOR THE SUPER USER . . . . .	46
12.5 PROCEDURE FOR SUPER USER PASSWORD CHANGE . . . . .	47
12.6 ALARM TABLE . . . . .	48
12.7 WARNINGS TABLE . . . . .	50
12.8 TROUBLESHOOTING . . . . .	51
12.9 FUSES . . . . .	51
12.10 RS232 LAN CONNECTION . . . . .	52

## 1 SYMBOLS USED IN THE MANUAL

Actions of particular importance or of potential risk and danger are highlighted in the manual with a symbol whose meaning is set out below.



**CAUTION!** This sign warns that if the operations described are not correctly performed, they can damage the machine.



**WARNING!** This sign warns that if the operations described are not correctly performed, they can cause serious injury.



**HAZARD!** This sign warns that if the operations described are not correctly performed, they can cause serious injury, death or long-term health risks. Please read carefully the User Manual.



**HAZARD!** This sign indicates hot surfaces. Danger of burns.



**HAZARD!** This sign indicates a potential risk of electric shock that can cause serious injury, death or long-term health risks.



**IMPORTANT NOTE!** Carefully read and memorize the information.

## 2 PRESENTATION

This use and maintenance manual is specific for the use of the washer disinfector, hereinafter also called machine (manufacturer data available on the cover).

This manual is an integral part of the washer disinfector itself, which must be kept in a safe place and known to the personnel in charge and must always accompany it when moved or resold.

The personnel in charge must be suitable and able to read and understand the contents of this manual. Furthermore, the personnel in charge must use the washer disinfector bearing in mind the accident-prevention regulations in force, the conditions of use and the washer disinfector features.

The same personnel must store it and keep it intact to allow its consultation throughout the life-span of the machine itself.

The personnel in charge must strictly and diligently follow the instructions, warnings and all indications contained in this manual.

The contents relate to normal use and maintenance operations. The manual does not include instructions for special interventions that are outside the routine use of the washer disinfector.

The removal and/or tampering with the safety devices and protections, fitted on the washer disinfector, will automatically void the warranty and liability of the manufacturer.



**WARNING!** The manufacturer also declines any and all liability for failure to comply with the safety and prevention regulations provided by the legislation and the provisions of this manual.

If the manual is damaged or lost, a copy must be immediately requested from the manufacturer.



**WARNING!** The machine must only be installed and dismantled by personnel trained for the purpose.

There is one model of washer disinfector discussed in this manual whose dimensions as shown in the figure below:

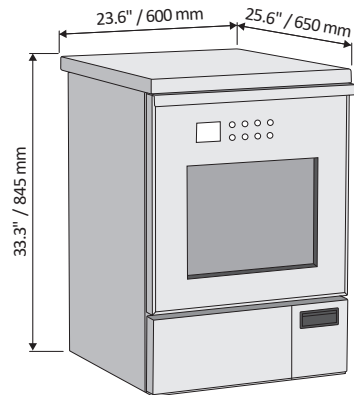

**Fig. 1**

The washer disinfector can be installed under the counter where appropriate space is already provided.



**WARNING!** Failure to comply with the instructions in manual, operational negligence, incorrect use of the washer disinfector and execution of unauthorized changes, both on the machine and on the programs, will be cause for cancellation by the manufacturer of the warranty granted.

For the installation schemes see the Installation Plan.



**IMPORTANT NOTE!** The Installation Plan must be considered as an integral part of this User Manual.

## 2.1 FIELD OF APPLICATION

This machine, intended for washing and disinfecting, is considered a class IIb medical device (as defined by Directive 93/42/EEC class IIb).

Follow the instructions of the instrument manufacturers (according to EN ISO 17664), as well as the national laws and directives for the automatic treatment of medical devices. The personnel in charge using the machine daily must be aware of its main features, and must also receive adequate and continuous training.

### 2.1.1 INTENDED USE

The washer disinfector is designed for the needs of cleaning and disinfecting non active and active surgical instruments, whose manufacturers expressly state that they can be treated in the machine.

Non active surgical instruments, such as:

- dental instruments;
- instruments for surgery and minimally invasive surgery (MIS);
- anesthesia and intensive care instruments;
- surgical instruments for ophthalmology;
- instruments for arthroscopy and rectoscopy (except for flexible endoscopes);
- instruments for ear, nose and throat surgery;
- instruments for gynaecology and urology;
- baby bottles and teats;
- ward end utensils such as kidney dishes, bowls and OP shoes.

Active surgical instruments, such as:

- Da Vinci arms.

### 2.1.2 INTENDED USERS

Specialized personnel capable of working in a CSSD, Dental clinics and Hospital's disinfection area.













### 2.1.3 INTENDED USE OF ENVIRONMENT

The machine is intended to be used only for internal uses. The machine is designed to be operational up to a maximum altitude of 6562 ft (2000 meters), at a temperature between 41 and 104°F (5 and 40°C) and used in an environment with a maximum humidity of 80% for temperatures up to 88°F (31°C), decreasing linearly to 50% at 104°F (40°C).

## 2.2 LABEL SPECIFICATIONS

The washer disinfector is equipped with an identification label (for position see Fig. 2). The following table shows the symbols used on the identification labels:

Symbol	Description
	Manufacturer of the device.

Symbol	Description
	Date of manufacture of the device.
	Device serial number from the manufacturer.
	Model name of the device.
	Indicates the permitted temperature range (min./max.) of the water supply.
	Flow pressure on the water inlet connected from min. to max.
	The user manual includes important safety information. Failure to comply with these instructions can result in injury and material damage. Please read carefully the User Manual.
	For indoor use only.
	Keep away from sunlight.
	Keep dry.
	Please read this user manual carefully before commissioning the device.
	The product complies with UL safety standards valid for both Canada and the USA.
	For the disposal of the machine please refer to chapter "Equipment Disposal".

## 2.3 WARRANTY

The manufacturer warrants the newly manufactured product for 12 (twelve) months from the date of the invoice of the Products unless specifically provided otherwise in the Contract or Order Confirmation. Within the aforementioned terms, the manufacturer will supply free of charge any part which, at its sole discretion, or of its authorized representative, shows manufacturing defects, or at its discretion, carries out repairs directly or through authorized personnel. In any case, labor costs for replacing defective parts are always charged to the Customer.

- The right of warranty services it is only recognized if, once the defect is found, it is immediately reported to the manufacturer, at the same time sending the

- related repair request.
- Without prejudice to the Customer's right of warranty service in the above terms, it is expressly excluded that the Customer may request termination of the contract, replacement of the product or reduction of the sale price, as well as compensation for any direct or indirect damage. In no case the Warranty entitled to equipment replacement.
  - The manufacturer grants the warranty at its discretion, according to the technical needs, to repair or replacement of the defective parts.
  - The replacement or repair of parts under warranty will not extend the warranty terms.
  - The expenses due to routine and special maintenance interventions on the product are, in any case, the purchaser's responsibility.
  - Transport costs, VAT and any custom duties are the purchaser's responsibility.



*IMPORTANT NOTE! The purchaser will only be able to enforce its warranty rights if it has complied with any additional conditions concerning the warranty service, also indicated in the supply contract.*

## 2.4 WARRANTY EXCLUSIONS

The warranty lapses (in addition to what stated in the supply contract):

- In case of Purchaser's failure on payment the Seller has the right to suspend the Warranty
- When the purchaser has not reported the vices to the seller within eight days of delivery, in writing and commissioning the execution of the related intervention.
- If the equipment is not used for its intended use or if it is modified or serviced by unauthorized personnel.
- Malfunctions due to voltage fluctuations or hydraulic pressure fluctuations or other external causes
- If the damages caused by bumps and falls
- If non original spare parts are used.
- For direct, indirect, incidental, consequential or special damages in connection with the condition, operation or no operation of the products, including, without limitation, personal injury, property damage, vegetation loss, the cost of substitution or replacement equipment or service required during periods of malfunction or resulting from non-use, nor any personal injury or property damage resulting from acts or omissions of installers.
- If the instructions regarding use, maintenance and assistance of the product, contained in this use and maintenance manual, have not been complied with.

- If chemicals not identified by the manufacturer as compatible with the product are used.

Without limiting the generality of the provisions above, Purchaser acknowledges that Seller does not install or service the Products and is not responsible for anything related to the installation or servicing of the Products.

The warranty covers all parts with the exception of consumable and wearable parts.

Damage deriving from negligence, carelessness, misuse and improper use of the machine is also excluded from the warranty.

For complex repairs or revisions, please contact specialized and authorized personnel or the Manufacturer directly, which is available to ensure prompt and accurate technical assistance and everything necessary for restoring the full efficiency of the product.

All disputes arising from or in connection with these Terms shall be judged exclusively pursuant to the Italian laws, without giving effect to its conflicts of law's provisions. The Court of Verona, Italy shall have exclusive jurisdiction to settle any and all disputes arising hereunder.



*IMPORTANT NOTE! This manual is the basic tool for personnel who, in various capacities, take care of the machine.*

- **USER:** The user is the person, body or company that has purchased or rented the machine and intends to use it for the intended purposes. The user must be perfectly familiar with all of command and control devices of the machine and must make sure that the personnel in charge have acquired all the information necessary for the use and routine maintenance of it. The user must also be able to perform these actions:
  - Machine commissioning and operation;
  - Loading and unloading of the material being washed on the racks;
  - Using the machine in all the different operating modes, such as the start-up of the different washing cycles provided;
  - Reset any alarms triggered;
  - Using all personal protection equipment, and complying with all adequate safety procedures, he/she should be able to carry out some routine maintenance operations, such as cleaning the clogged filters on the chamber bottom and filling the machine with cleaning liquids and chemical additives.
  - Select his/her username and insert the appropriate password when this option is enable for running

a program (USER PIN MANAGEMENT option on request).

- **SUPER USER:** Is the user that has special access to the device's menu for extra settings.
- **SERVICE PERSONNEL:** The person(s) in charge of installing, operating, adjusting, maintaining, cleaning, repairing and transporting the machine. Can perform every operation concerning machine positioning at the User's premises, the connection of different systems, machine commissioning, the routine and special maintenance and the repairs that require special knowledge of the machine. The service personnel is also able to recognize the dangers deriving from incorrect or improper use of the machine itself and to proceed with the final demolition of the machine.

Before proceeding with the various operations, the above listed operators, must have carefully read and become familiar with this manual.

The washer disinfectant packaging, in addition to the machine's documentations, contains the two spray arms that will be applied on the chamber, the flexible hoses for the hydraulic connections the drain pipe, the supply wire, the emergency release key and the USB key.

Upon delivery, check that the washer disinfectant is intact and that the above-described material is actually present.

For the installation, wiring and hydraulic diagrams (water filling and draining) contact the manufacturer.

## 2.5 PRODUCT ANALYSIS

The washer disinfectant was tested by applying «UL 61010-1 CAN/CSA-C22.2 61010-1-12 IEC 61010-2-010 61010-2-040 Safety requirements for electrical equipment for measurement, control, and laboratory use Part 2-040 Particular requirements for sterilizers and washer disinfectors used to treat medical materials», where the machine is expected to:

- use with a primary voltage fluctuation up to  $\pm 10\%$  compared to the nominal voltage;
- use with a temporary type overvoltages:
  - of short duration, which may occur between the line conductor and the system earthing, which may have a voltage equal to the power supply voltage on the line-neutral +1200V, and a duration up to 5s;
  - of long duration which may occur between the line conductor and the system earthing, which may have a voltage equal to the power supply voltage on the line-neutral +250V, and a duration greater than 5s;
- overvoltage category II;
- pollution degree 2.

- The validation of the product was made by the manufacturer in compliance with standard ISO 15883.
- The machine does not cause harmful vibrations.
- The residual radiation emitted within the limits is non-ionizing.
- The shelf life cycle of the device is 10 years.
- The machine must not be dumped when scrapped, as it contains materials subject to legislation requiring disposal at special centres.

### 2.5.1 INLET WATER QUALITY

The quality of the water used in all stages of cleaning is important for good results.

The water used in each stage must be compatible with:

- The material which the machine is made of.
- The chemicals used in the process.
- Process requirements for the various stages of the process.

The main factors for good inlet water quality in relation to the effectiveness of washing are:

#### HARDNESS

The high hardness of the water generates a detergent inactivation, reducing its efficacy. It also causes limescale deposits in the machine, jeopardizing the cleanliness of the instruments and the machine, especially on hot parts (ex. heating elements).

#### IONIC CONTAMINANTS

A high concentration of ionic contaminants may cause corrosion of steel, manganese or copper instruments.

#### MICROBIAL CONTAMINANTS

Microbial contaminants can increase the microbial contamination of the instruments at the end of the wash.

#### The manufacturer therefore recommends that:

- the water used in the pre-rinse and washing stage should be of drinking quality according to the "Guidelines for drinking-water quality, 4th edition" published by the WHO.
- deionized water is used for the rinsing and disinfection. A typical specification for deionized water is:

Ion concentration H+	4.5...7 pH
Conductivity	< 30 $\mu\text{s}/\text{cm}$
TDS	< 40 mg/l
Maximum hardness ( $\text{CaCO}_3$ )	< 10 mg/l
Chlorine	< 10 mg/l
Heavy metals	< 10 mg/l
Phosphates	< 0.2 mg/l as $\text{P}_2\text{O}_5$
Silicates	< 0.2 mg/l as $\text{SiO}_2$
Endotoxins	< 0.25 EU/ml

Colony-forming units (CFU) < 100 for 100 ml (\*)

(\*) for rinsing after disinfection phase, the maximum limit changes to 0.

Further advice should also be obtained from manufacturers of chemical and medical equipment. Where local standards are stricter than the provided recommendations, they should be followed.



**IMPORTANT NOTE!** it is the user's responsibility to supply the machine with suitable water.

**2.6 TECHNICAL DATA**

**Description**

Width	23.6" 600 mm
Depth with door closed	25.6" 650 mm
Height	33.3" 845 mm
Weight*	220 lbs 100 kg

\*The weight may vary depending on the configuration.

**Washing chamber dimensions:**

Width	21.7" 550 mm
Depth	19.7" 500 mm
Height	23.6" 600 mm

Protection absorbed power voltage See data plate and the installation plan

Max dBA noise during wash phases <56 dB (A)

Max dBA noise during drying phase <61 dB (A)

Type of protection (according to IEC 60529) IP20  
IP: International Protection. Against ingress of solid foreign objects: ≥ 12,5 mm diameter. Against ingress of water with harmful effects: 0 (non-protected).

CE marking Directive on medical devices 93/42/EEC, class IIb

- Steam condenser: 0.08 US gal (0.3 l).
- Machine without water softener: 0.11 US gal (0.4 l).
- Machine with water softener (resins and salts): 0.4 US gal (1.6 l).

**2.6.1 MAIN COMPONENTS OF THE MACHINE**

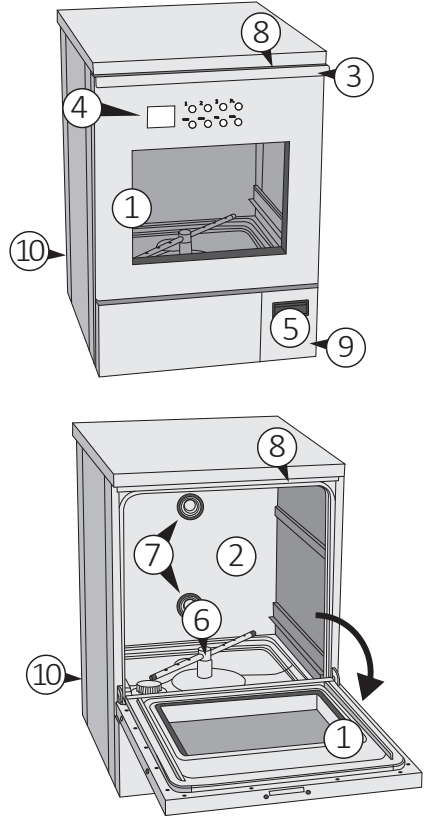

**Fig. 2**

- 1) Upper door with tempered glass.
- 2) Internal chamber.
- 3) Upper door opening handle.
- 4) Control panel.
- 5) Air suction filter.
- 6) Lower spray arm.
- 7) Connection point for washing racks.
- 8) Hole for emergency release.
- 9) Machine label placed behind the filter panel.
- 10) Machine label placed on the back of the machine.

At the end of each cycle, a residue volume of water remains inside the machine, divided as specified below:



## 2.7 ACCESSORIES

The machine leaves the factory with the following accessories:



**Fig. 3a**

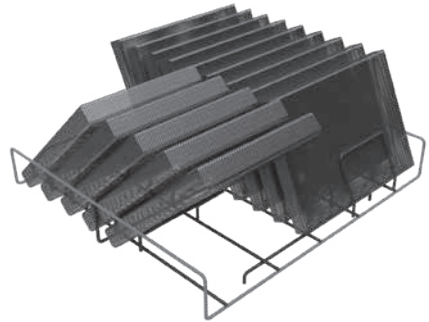

**Fig. 3e**

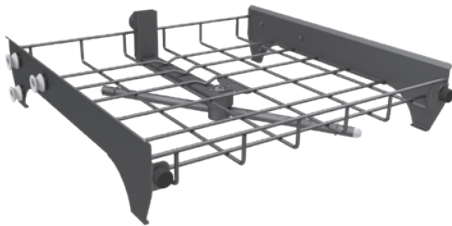

**Fig. 3b**

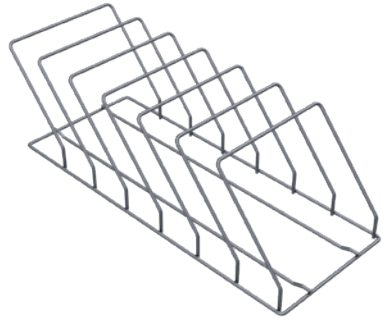
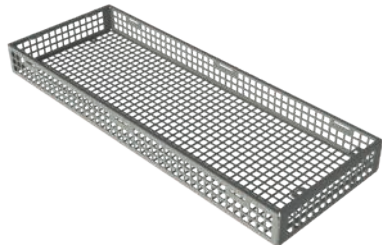

**Fig. 3f**

The user must request the most suitable accessory from the manufacturer:



**Fig. 3c**



**Fig. 3g**



**Fig. 3d**

- 3a: Washing rack positioned at the lower level, basic version.
- 3b: Washing rack with spray arm positioned at the upper level, basic version.
- 3c: 1/1 DIN basket manufactured in stainless steel, suitable for washing all kinds of instruments.
- 3d: Support grid for racks positioned at the upper level, allows to use DIN baskets.
- 3e: Insert for washing up to 14 trays or cassettes.
- 3f: Insert for washing up to 6 trays or cassettes
- 3g: 1/3 Basket manufactured in stainless steel, suitable for washing all kinds of instruments.

## 2.8 MACHINE STAND

The washer disinfectant can be customized with a stand that provide an ergonomics height of 57.5" (146 cm). It can be used when the machine is not installed undercounter. It is suitable for use as a chemical's tank storage compartment.



**Fig. 4**

For installing the stand:

- 1) Raise the machine and place it on top of the stand.
- 2) Open the stand's door and install the stand on the bottom plate of the machine using the 4 fixing screws supplied in the packaging. Make sure that they are properly tightened.
- 3) Adjust the feet on the lower stand so that the machine is level.



**WARNING!** Fix the stand to the floor with screws.

## 3 SAFETY AND PREVENTION

The operator in charge must be instructed on the risks deriving from accidents, on the devices prepared for the safety of the operator and on the accident-prevention rules provided by the legislation of the country of use of the machine. When realizing the machine, all potentially dangerous situations have been foreseen and appropriate protections have been adopted. However, the level of accidents caused by careless and awkward use of the machine remains high. Distraction, carelessness and too much confidence are often cause of injuries; as well as tiredness and sleepiness. It is, therefore, mandatory to carefully read this manual, in particular section "3 Safety and prevention".

## 3.1 GENERAL WARNINGS

### 3.1.1 USER OBLIGATIONS

- The user undertakes to entrust the machine only to qualified and trained personnel.
- The user undertakes to set up an electric circuit breaker with an effective regulatory earthing system and the various connections for water inlet and drain.
- The user is required to take all measures to prevent unauthorized people from using the machine.
- The user undertakes to adequately inform and train its personnel on the application and observance of the safety regulations.
- Failure to comply with these rules may jeopardize the safety of the device and IMMEDIATELY void the warranty.
- The user must inform the manufacturer if defects or malfunctions of the accident-prevention system are found, as well as any presumed dangerous situation.
- The user undertakes to use only original spare parts. Otherwise, the warranty lapses. It also undertakes not to intervene for any repair work.

### 3.1.2 INSTALLER OBLIGATIONS

- The washer disinfectant must be installed and set up for use exclusively by specialised personnel and authorised by the manufacturer.
- Check that the machine has not been damaged during transport and handling.
- Use the washer disinfectant only in environments that are not at risk of fire and/or explosion and in rooms at ambient temperature.
- Before installing the equipment, ensure that the supply voltage complies with the one shown on the identification plate and that the water supply pressure is equal to the one indicated in the technical data. Furthermore, make sure that the drain matches the dimensions provided on the installation drawing.
- The electrical and water connections can only be made by specialised service personnel, paying particular attention not to crush the power supply cable and the water flexible hoses.
- Do not install the machine in the same room where patients are housed. The machine can heat the environment, thus increasing humidity.

### 3.1.3 OPERATOR OBLIGATIONS

- Before starting to operate for the first time, become familiar with the control devices and their functions.
- The operator must not carry out operations or interventions which are not within his/her competence on their own initiative.
- It is strictly forbidden to operate or have the machine operated by anyone who has not read and

understood the information in this manual, as well as by unskilled personnel who are not in good mental and physical health.

- The machine must not be operated with the guards removed or partly damaged.
- Use the washer disinfectant only for the operations described in this manual.
- Do not damage or change the power cable or plug.
- Never start the machine if the cable or plug are damaged.
- Do not pull the power cable to unplug it. Always act on the plug.
- Use detergents and additives specific for manufacturer-approved washer disinfectants. Always observe the manufacturer's instructions. If, despite this, the product has negative effects on the instruments or machine, the responsibility will be of the manufacturer of the cleaning liquids.
- Only introduce instruments that can be treated with automatic cleaning and disinfection process (see manufacturer's instructions). It is particularly important to follow the manufacturer's instructions when inserting new instruments that are used for the first time.
- If additional accessories are used to load the instruments, especially hollow ones, the instructions contained in the manufacturer's instruction manual must be observed.
- Take care not to injure yourself by arranging sharp or pointed objects vertically. Try to arrange them in such a way as to prevent anyone from injuring themselves.
- Handle the chemical products with care. Chemicals for cleaning, neutralizing and rinsing contain irritants and caustic substances.
- The water in the chamber is not drinkable.
- Do not lean on the door and do not use it as a step.
- The machine during its work cycle could reach a temperature of 203°F (95°C); be very careful: there may be a risk of scalding.
- Do not change, for any reason, the characteristics of the appliance, its installation specifications and the parameters set.
- At the end of loading and unloading the instruments to be used, always close the door in order to avoid possible unpleasant smells coming from the drain.
- In case of fire, to extinguish the flames intervene with a powder fire extinguisher, DO NOT USE WATER.
- Do not wash the machine with direct or pressure water jets, or corrosive substances.
- Do not use the machine to wash objects and/or containers that, because of their shape or material, are not compatible with the indications given by the manufacturer. For objects to be washed, please follow

- the instructions explicitly indicated in this manual.
- In case of long outage periods of the machine, please cut the power supply off and close the water taps.
  - Do not try to open the chamber door during operation: the appliance is equipped with a special safety lock system to prevent the door from being opened.



*HAZARD! Pay attention where indicated, for a potential danger of hot surfaces highlighted on the machine with this pictogram.*



*HAZARD! Pay the utmost attention where indicated, for a potential electrical hazard highlighted on the machine with this pictogram.*

### 3.1.4 MAINTENANCE SERVICE PERSONNEL OBLIGATIONS

- Periodically check the integrity of the machine as a whole and the protection devices.
- Respect the laws in force in the country of use of the machine, in relation to the use and disposal of the products used for cleaning and maintenance. Dispose of any special waste through appropriate companies authorised for this purpose, with issue of a receipt of the successful disposal.
- The assembly of parts of other brands or any changes (in addition to voiding the warranty), can vary the machine characteristics and, therefore, compromise its operational safety.
- If the protective casings are removed, make sure that they are correctly restored before reusing the machine.
- At the end of the maintenance and repair operations, before restarting the machine, make sure that the work is completed, the safety devices reactivated and the guards reassembled.
- It is strictly forbidden to remove or tamper with the safety devices.
- The machine maintenance must only be performed with the power supply off, by qualified personnel and following the instructions in this manual.

## 4 HANDLING

Usually the packaged and palletised machine is transported to the retailer/dealer who, by means of its personnel and suitable means, in compliance with current regulations, will itself make the delivery to the end user, ensuring transport and unloading operations depending on the type of transport vehicle.

Each package, on the outside, shows the machine handling instructions in brief.

During storage or handling the contents are not sterile. Upon delivery, check that the washer disinfectant is intact and that the material indicated in the delivery document is actually present. In case of damage or inaccuracies in the delivery, immediately notify the manufacturer of the extent of the damage or inconsistencies found.

Should the need arise for transfers, the machine can be easily loaded on suitable equipment and on the available lifting equipment.



**HAZARD!** The loading/unloading operations can be very dangerous if not carried out with the utmost care. Therefore, before starting loading/unloading, move unauthorised persons away; clear and delimit the area where the operation takes place, and check the integrity and suitability of the lifting and transportation equipment available.

Also make sure that the area of operation is clear and that there is sufficient “escape space”, that is, a free and safe area, in which to move quickly in the event that the load falls. Before loading, check that there is sufficient space on the surface of the transport vehicle to accommodate the machine to be transferred.



**WARNING!** After loading the machine, secure it firmly to the surface on which it rests with taut ropes to block any possible movement.

After carrying out the transport and before releasing the machine from all constraints, check that the status and position cannot constitute danger.

Therefore, remove the ropes and unload using the same equipment and methods used for loading.

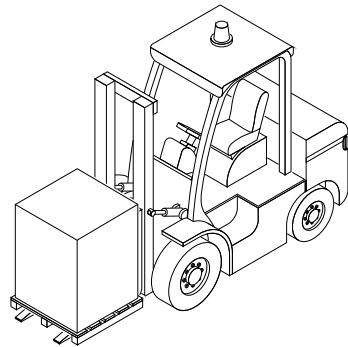

**Fig. 5.1**

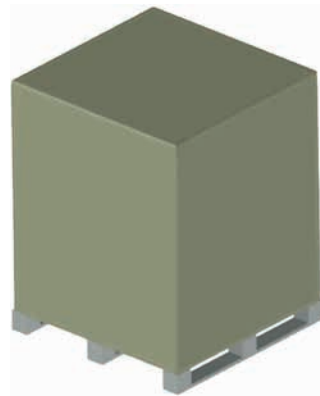

**Fig. 5.2**



**Fig. 5.3**

- Handle the packaged machine only with forklift truck or pallet trucks with forks (Fig. 5.1).
- Remove the “hat” container, extracting it from the top (Fig. 5.2).

- Handle the machine with appropriate trolley. Lock the machine on the trolley with a sturdy belt (Fig. 5.3)

Do not lift the machine by grasping it from the protruding points, such as the control panel. They may be damaged or detached. With some metal components there is a danger of injury or cuts.

 **WARNING!** Wear cut-resistant protective gloves during manual transport and positioning of the machine.

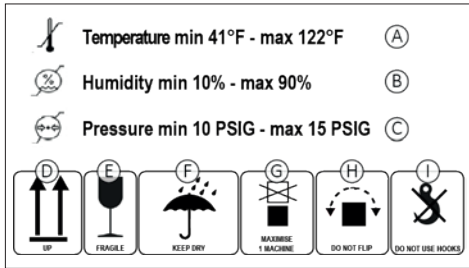

Fig. 6

A label is placed outside the packaging (Fig. 6) that indicates:

- A) Minimum and maximum temperature of the storage environment;
- B) Minimum and maximum humidity of the storage environment;
- C) Minimum and maximum pressure of the storage environment;
- D) "High" position indicators;
- E) Glass indicating "Fragile" material;
- F) Keep the packaging dry;
- G) A maximum of one machine can be stacked;
- H) Do not overturn the packaging with the machine inside;
- I) It is strictly forbidden to use hooks for handling the packaged machine.

Inside the packaging, in addition to the machine and the documentations, there are:

- the two spray arms that will be applied on the chamber;
- 2 drain pipe;
- the emergency release key;
- the USB key.

If the machine is to be moved, it is advisable to keep the packaging for any other relocation.

If this is not provided, dispose of the packaging materials: cardboard, polystyrene and other, separated by single material, sending them to the most

appropriate final destination, which may be recovery or storage in landfills.

**4.1 STORAGE**

If the packaged machine is temporarily stored, make sure that it is not subjected to blows and tampering. However, it must be placed in a closed, dry, dust-free environment and protected from atmospheric agents. When restored, a careful preliminary examination of its integrity by specialised personnel is necessary. Absolutely avoid overlapping weights or foreign bodies on the packaging and the machine.

**5 INSTALLATION**

It is advisable that only furniture for professional use be positioned in the area around the machine, to avoid ruining them due to possible leakage of condensation water.

 **IMPORTANT NOTE!** For a safe installation, the electrical disconnecter/plug of the device must be positioned free from any obstacle and in a visible and accessible position for the operator, so that it's easy to control it in case of emergency or prolonged safe disconnection.

 **HAZARD!** Do not install and/or use the washer disinfectant in environments with flammable/explosive atmosphere.

 **WARNING!** Make sure that the floor is fit to support the load of the equipment when in operation.

 **WARNING!** Make sure that the machine is perfectly vertical and stable, using a spirit level, if necessary.

Unevenness of the machine surface and height can be adjusted with the two adjustable feet placed under the machine itself.

 **HAZARD!** All electrical and water connections (loading/unloading) can only be carried out by specialised and authorised personnel and by consulting the relative diagrams.

Before machine positioning make sure that:

- All the components needed for installation and proper use of the machine were installed: main switch, water

supply taps, drain and anything else needed.

- These components should have all the needed features and should be installed at the locations shown in the installation scheme.



**WARNING!** The use of unsuitable parts, and/or the implementation of installation procedures other than those shown on the installation diagram, will immediately void the machine warranty.

- The characteristics of the electricity network must be compatible with the values required for correct operation indicated on the machine identification plate and on the technical data sheet.
- The machine must be connected to an efficient earthing system (according to electrical safety standards).



**IMPORTANT NOTE!** The manufacturer is not to be held liable for any damage caused by improper grounding of the machine or faulty power supply.

## 5.1 UNDER THE COUNTER INSTALLATION

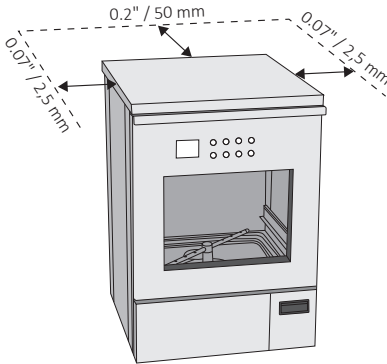

**Fig. 7**

The under the counter machine can be inserted under a continuous worktop or under the sink's drip surface. The recess niche must have a minimum space as shown in Fig. 7.

The presence of adequate air intakes must be guaranteed to allow the ventilation of the area behind the machine, in order to avoid creating a closed space without exchange of air with the room environment.

## 5.2 ELECTRICAL CONNECTION



**HAZARD!** Only qualified and experienced personnel can connect the machine to the mains supply, in compliance with the current laws and regulations.



**WARNING!** In the single-phase version, the main switch of the power supply line must be a multi-pole circuit breaker, with adequate residual current protection.



**WARNING!** In the three-phase version, the main switch must be multi-pole circuit breaker, with adequate residual current protection, positioned near the machine and not covered by machines or other that may hinder its use.

- The magnetic-snap safety system, or the fuses, must be calibrated according to the power indicated on the machine plate.
- Make sure that the measured voltage is equal to the one reported on the identification plate of the machine;
- Check that the voltage does not differ by more than 10% from its rated value;
- Make sure that the electrical system is equipped with an efficient grounding connection;
- Connect the cable that comes out of the machine to the wall socket. In case the machine has a three-phase connection (standard), connect the cable installed on the machine to the three-phase plug and insert it into the interlocked socket next to the machine (not provided).
- The socket must be accessible after the machine installation. This facilitates verification of the electrical safety, e.g. in repair or maintenance interventions.
- The machine must be supplied with current whose voltage, frequency and protection values correspond to those indicated on the data plate.
- Additional indications regarding the electrical connection are shown in the installation plan.



**IMPORTANT NOTE!** The fuses must be in compliance with Standards IEC 60127-2, UL248-14, CSA C22.2.

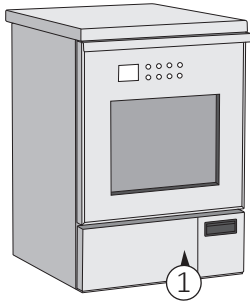

Fig. 8

**Positions of the fuses (Fig. 8):**

1) Fuses in the machine



**HAZARD!** Damaged fuses must be replaced by authorised personnel (for the value and size of the fuses see Annex 12.9).

**5.2.1 ELECTRICAL CONNECTION**

Connection of the machine to the electrical mains must be made by qualified, skilled personnel.



**WARNING!** Power supply cable: it is compulsory for the retailer - installer to adapt the insulation class of the power supply cable to suit the working environment in compliance with current technical regulations.

- Check that the electric specifications match those shown in the label.
- The electrical connection must be carried out in compliance with current technical regulations.
- Make sure that the primary voltage reading corresponds to the voltage indicated on the machine plate.
- Check that the power supply voltage does not differ by more than 10% from its nominal value.
- The frequency of the power supply voltage must not differ by more than 1% of its value.
- Connection of the machine to the mains must be provided with an earth connection and an equipotential circuit as set forth by current standards.
- Make sure that the electrical systems are efficiently earthed.
- The earth conductor is to be connected to the earth terminal identified by the standard symbol. 

- The machine is equipped with a terminal identified by the relative symbol for equipotential connections between appliances (see rules for electrical plants).



- Connect the machine by using the power cable supplied with the machine.
- In case of prolonged use of the machine it is recommended that you execute the disconnection procedure of the electrical connection by placing the dedicated safety device in "OFF" state.
- The upstream electrical power line must be dimensioned and protected in accordance with current local regulations.

**Electromagnetic compatibility (EMC)**

The machine has been tested on electromagnetic compatibility pursuant to Standards IEC 61326-1 + EN 61326-1 and is suitable for operation in institutes such as hospitals, laboratories, medical practices and environments connected to the public electricity grid.

The high-frequency (HF) energy emissions of the machine are so small that interferences with electrotechnical equipment in the immediate vicinity are not likely.

The optimal positioning floor must be made of concrete, wood or ceramic tiles. In case of machine operation on floors made of synthetic materials, the relative humidity must be 30% to minimise the likelihood of electrostatic discharges.

**5.3 WATER CONNECTION**

**CAUTION!** The water in the wash chamber is not drinkable.

The quality of the water used must be compatible with the manufacturing materials of the machine, with the chemicals and with the process needs in the various stages of the procedure.

To have good washing results, the water must be soft and low in limestone. With hard water white patinas deposit on the objects to be treated and on the walls of the wash chamber.

For the correct operation of the machine, the water inside the washing chamber must have a maximum hardness of 0.7 mmol/l CaCO<sub>3</sub> (3.9°DH / 7°fH). If the installation site does not have water with the required specification, the machine must be equipped with an internal softener (option available).

The water used in all the washing stages should be of drinking quality according to the "Guidelines for drinking-water quality, 4th edition" published by the

WHO. A high iron content can cause rust on the load and in the special washing machine. If industrial water contains a higher amount of chlorides than 100 mg/l, the risk of corrosion significantly increases.

Water hardness conversion table:

French degrees [°fH]	CaCO <sub>3</sub> [mmol/l]	German degrees [°DH]	CaCO <sub>3</sub> [PPM]
0-10	0-1.01	0-5.60	0-100
11-15	1.11-1.51	6.16-8.40	110-150
16-20	1.61-2.02	8.96-11.20	160-200
21-25	2.12-2.52	11.76-14.00	210-250
26-30	2.62-3.03	14.56-17.80	260-300
31-35	0-5.60	17.36-19.60	310-350
36-40	6.16-8.40	20.16-22.40	360-400
41-45	8.96-11.20	22.96-25.20	410-450
46-50	11.76-14.00	25.76-28.00	460-500
51-55	14.56-17.80	28.56-30.80	510-550
56-60	5.66-6.06	31.36-33.60	560-600

The special washing and disinfecting machine is standard prepared for connection to cold and hot water. Connect the flow pipes to the shut-off valves for cold and hot water.

- The machine must be connected to the water mains in accordance with current regulations.
- If the water supply of the device has not been used for a long time, or if it is used for the first time, purge it by draining the water into a container or into a drain for a few minutes in order to remove any impurities, air bubbles and/or whatever may damage the machine and clog its filters.

	Cold water	Hot water	Deion. water
Min. temperature	41°F 5°C	113°F 45°C	41°F 5°C
Max. temperature	68°F 20°C	158°F 70°C	68°F 20°C
Recommended flow pressure	43 PSIG 300 kPa	43 PSIG 300 kPa	43 PSIG 300 kPa
Min. flow pressure	29 PSIG 200 kPa	29 PSIG 200 kPa	29 PSIG 200 kPa
Max. flow pressure	72 PSIG 500 kPa	72 PSIG 500 kPa	72 PSIG 500 kPa

- Connect the cold, hot and deionized (if available) water hoses, exiting the machine with their respective network connections, as shown on the installation drawing. It will be the responsibility of the installer to make sure that the temperature of the cold water

supply is correct, otherwise proper washing of materials cannot be ensured. The connections for cold and hot water must not feed any equipment other than the washer disinfecter. During the washing cycle, this is necessary to prevent the subdivision of the water supply with other users, thus leading to a substantial increase in the time required to fill the chamber (in this case an alarm will be triggered to alert the user that the maximum time allowed for water loading is exceeded).

- If the machine is provided with a deionized water feeding system but the plant is not equipped with it, the cold and deionized water hoses should be connected together.
- The machine can be equipped with a built-in softener, which has the function of reducing the scale in the water supplied
- Connect the flexible hoses to the machine valves positioned in view at the back, making sure to connect them correctly based on the sales configuration.
- Make sure to connect the water flexible hoses in the positions shown in Fig. 9.
- Connect the water flexible hose to connections shown in Fig. 9.
- If present, install the Disconnecter CA while maintaining a clear area of 6" (150 mm) around the valve (For more information see the Installation Plan).



**HAZARD!** Be careful in case of a blockage of the drain which could cause spill out of water and the risk of slippery floor.

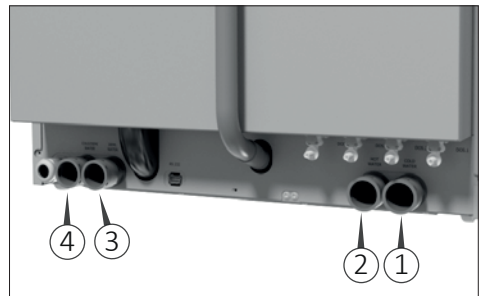

**Fig. 9**

**Water connections (Fig. 9)**

- 1) Cold water connection.
- 2) Hot water connection.
- 3) Deionized water connection.
- 4) Cold water condenser connection.



 **WARNING!** The flow pipes must not be shortened or damaged.

The water supply taps must be capable of quickly stopping the water line, therefore, they must be equipped with a ball or a gate valve. They must also withstand the operating pressure of the water, as indicated in the technical data sheet.

Proper placement of the taps is shown on the installation plan.

**5.3.1 ACQUASTOP SYSTEM**

The water connection hoses are fitted inside with two solenoid valves, connected to the float switch. If a water leak is detected, the float is triggered, causing the solenoid valves to close.

**5.3.2 MODELS WITH BUILT-IN WATER SOFTENER**

The integrated function of the softener is used to reduce the amount of limescale contained in the incoming water. If the machine is connected with hard water, the result is a rapid degeneration with loss of function and performance.

Regeneration must be performed to keep the ionic resins active.

For machines equipped with a water softener, when installed, it is necessary to enter the water hardness value by entering in programming menu.

Hardness in French degrees [°fH]	Setting parameter	Regeneration
0-10	Value 0	No regeneration
11-15	Value 13	every 13 cycles
16-20	Value 11	every 11 cycles
21-25	Value 9	every 9 cycles
26-30	Value 8	every 8 cycles
31-35	Value 7	every 7 cycles
36-40	Value 6	every 6 cycles
41-45	Value 5	every 5 cycles
46-50	Value 4	every 4 cycles
51-55	Value 3	every 3 cycles
56-60	Value 1	*Regeneration at every cycle

*\*Recommended only for expert users.*

Actions for salt refill:

- 1) Open the door.
- 2) Unscrew the plastic cap of the salt box.
- 3) Pour 0.7 kg (1.5 lbs.) of common salt into the box using the appropriate funnel.

 **WARNING!** During this operation, check that the plastic cap is closed.

- 4) Insert the rack and start a normal washing cycle. The machine regenerates automatically.

 **WARNING!** The washing cycle performed after the «salt loading» may not work.

**5.3.3 REGENERATION SALT**

If the water softener was chosen when configuring the machine, the washer disinfectant is supplied with regeneration salt which will feed the device automatically during the regeneration process.

You must fill the salt tank every time the message “Refill salt” is displayed.

- Use only appropriate coarse-grain salt.
- Do not use kitchen salt, crushed salt tabs or other types different from those indicated, as it may contain insoluble substances.
- Do not pour cleaning liquids or other solutions in the salt tank.

 **WARNING!** Failure to comply with these recommendations can lead to a malfunction of the water softening device. Just before the salt runs out completely, the display will show the message «Lack of salt». At this point, the salt should be topped-up as soon as possible, otherwise an error message will appear and it will no longer be possible to activate a new cycle if not by resetting.

The salt must be introduced through the chamber outlet inside the tank (4 Fig. 11). To introduce the salt, unscrew the cap (anti-clockwise) and fill the tank with salt funnel, paying attention not to pour salt outside the bowl then close the tank with the cap.

**5.3.4 SALT REFILL**

Proceed as follows to refill the salt:

- 1) Delete the message on the display by pressing the RESET key for 5 seconds.
- 2) Open the door and remove any already inserted load.
- 3) Loosen the salt tank cap and insert the funnel.
- 4) In the first filling, introduce 0.13 US gal (0.5 l) of water to dissolve the residue salt. **FIRST FILLING ONLY**
- 5) Fill with salt up to the edge. The tank contains about 1.5 lbs (0.7 kg) of salt.

- 6) Thoroughly clean the edge of the salt tank.
- 7) Tighten the cap again.
- 8) Run a «Prewash» program to clean the salt residues inside the wash chamber.

- It is absolutely necessary to remove any salt residues that may have settled in the chamber after refill and before rinsing.

- After each top-up, start the «Prewash» program. In this way, any salt grains will dilute and rinse out. Salt residues and the overflowing water and salt solution can cause corrosion if they are not rinsed.

Following the instructions in the chapter "Starting the Machine", start a «Prewash» program.

---

⇒ **IMPORTANT NOTE!** After the salt refill action, the first wash cycles may fail.

---

⇒ **IMPORTANT NOTE!** The "Refill Salt Tank" alarm may persist for few hours after the salt refill action, until the brine is being created. This will not affect the functionality of the device.

---

### 5.3.5 AUTOMATIC REGENERATION

It is possible to have a water softening device that can completely regenerate at precise intervals. This process is fully automatic. Regeneration will be implemented before the selected program is activated.

This device must be preset by the service personnel during installation.

Regeneration can also be performed manually, regardless of the warning message on the display.

### 5.4 CONNECTION OF THE DRAIN TRAP

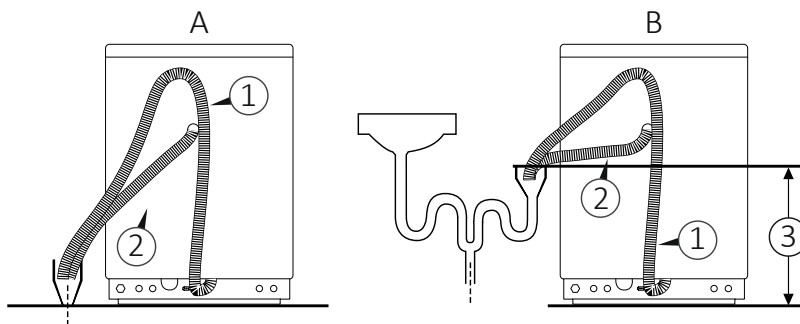

**Fig. 10**

**Water and drain system (Fig. 10):**

A) Floor drain connection.

B) Wall drain connection.

1) Hose connection waste water.

2) Hose connection capacitor discharge machine.

3) Minimum connection point 3.9" (100 mm).

Maximum connection point 23.6" (600 mm).

The machine is equipped with a built-in drain trap which must be mandatorily connected to the drain system of the building.

The user must carry out periodic maintenance of the drains and check that they are not clogged.

Before connection:

- supply the water connections with separate shut off valves;

- flush out the water pipes that are to be connected to the machine, to prevent clogging of filters and valves;

Procedure:

1) Connect the machine to water connections (Fig. 9).

2) Connect the grey drain pipe to the drain connection located at the back of the machine.

The correct positioning and sizing of the drain trap are shown on the installation drawing (see the Installation Plan).

---

⇒ **WARNING!** The washer disinfector drain pipe must be maintained if backflow and other drainage issues are to be avoided. Keep the drain pipe free from kinks and knots, and minimize the number of twists and turns in the pipe. Be careful not to crush the pipe. If the pipe has been crushed, kinked, or otherwise damaged, consider replacing it to prevent future drainage issues.

---

### 5.4.1 DRAIN CONNECTION

The waste connection must be properly installed according to the applicable instructions.



**WARNING!** If the waste connection is installed incorrectly, the waste water could flow backwards into the machine's chamber.

### 5.4.2 WASTE HOSES

The hoses:

- must be laid out so that they are not bent, pinched or tangled;
- may not be connected together before reaching the connection point;
- may not hang below the machine's lower edge.

### 5.4.3 CONNECTION POINT FOR WASTE

- The connection point must have a capacity of 9.3 GPM (35 l/min) and must have a diameter of at least DN 1.5" (40 mm).
- The hoses may be hung up using the accompanying hose holder.



**WARNING!** The manufacturer is not liable in case of environmental pollution due to an incorrect use of the washer disinfecter.

## 5.5 FILTERS AND SPRAY ARMS

### 5.5.1 CHAMBER FILTERS



**Fig. 11**

**Filter unit (Fig. 11):**

- 1) Central filter.

- 2) Mesh filter.

- 3) Chamber bottom filter.

- 4) Salt tank cap.

Insert the supplied filters in the specific positions. Constantly check the cleanliness of the filters, especially the chamber bottom filter (3 Fig. 11).

Use this filter to have a high filtering, taking into account that it will have to be cleaned after each cycle performed to avoid an excessive build-up of dirt.



**IMPORTANT NOTE!** In case of washing shoes, clogs and instruments with particle-sensitive dirt, it is recommended to remove the chamber bottom filter before the washing cycle, in order to avoid to clogging it. If the chamber bottom filter is not removed, it is recommended to clean it after each washing cycle.

Insert the mesh filter (2 Fig. 11) and place it in the chamber seat. Finally, insert the central filter (1 Fig. 11) in the mesh filter hole.

### 5.5.2 SPRAY ARMS

The two spray arms are supplied loose to avoid possible breakage during transport. Place the two spray arms (lower and upper) in their seats and tighten them to the relative central pin inside the chamber (Fig. 12.1).



**Fig. 12.1**

After fixing the spray arms, carry out a test by manually turning it, making sure that they rotate freely and without impediments.

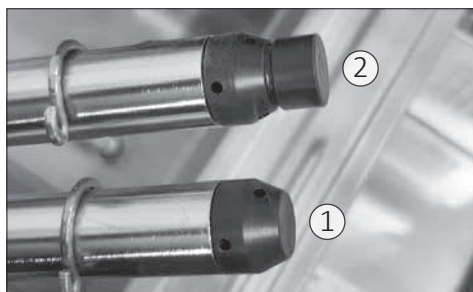

**Fig. 12.2**

**Spray arm rotation identification (Fig. 12.2):**

1) Spray arm without magnet for identification.

2) Spray arm equipped with magnet for identification.

After machine positioning, make sure nothing is preventing the chamber door from being freely opened. Make sure the machine is connected properly to the electrical supply, to the water supply and to the drain trap, then level it by adjusting its feet. After installation remove the PVC protection layer covering the panels, make sure the liquid tanks are full and the suction nozzles are properly inserted into the right tanks. A label next to the cap indicates the type of liquid to be used for each suction tube.



**WARNING!** Spray arm assembly direction, the water outlet holes must face towards the inside of the chamber otherwise the spray arms will NOT work.

**5.6 CHEMICALS**

The washer disinfectant adopts as standard 2 pumps for dosing detergent and neutralizer agents, on request it can have up to a maximum of 4 dosing pumps for:

- Detergent agent.
- Neutralizer agent.
- Lubricant/Rinse aid.
- Additive.

Each dosing pump is monitored by a dosing volume control. This electronic control checks the dosing amount.

In the event of a lack of product, a message appears on the display and the program stops.



**WARNING!** It is recommended to handle the liquids with caution.

- Protect eyes, hands, clothes and metal surface from contact with liquids, which contain partially irritating

agents and caustic substances.

- In case of contact with liquids, consult the instructions provided with the product.
- Use only suitable liquids for cleaning equipment. Carefully follow the manufacturer's information.
- Keep chemicals out of the reach of children and outsiders. Possibly locked away.
- Use on only the manufacturer's approved products.
- Do not use liquids for household dishwashers.

**5.6.1 REFILL PROCEDURE**

- 1) Set up a new tank with the chemical.
- 2) Remove the suction lance from the exhausted tank.
- 3) Insert the suction lance in the new tank.
- 4) With the door open, press and hold key P1 (1 Fig. 13) to refill DOS1 for the detergent; key P2 (2 Fig. 13) to refill DOS2 for the neutralizer; key P3 (3 Fig. 13) to refill DOS3 for the lubricant/rinse aid liquid; key P+ to refill DOS4 (4 Fig. 13) for additive liquid.

Be careful not to reverse the position of the liquids.



**WARNING!** Failure to follow these recommendations may damage the washer disinfectant.

- With regard to the maximum dosage for each program, follow the instructions of the chemical manufacturer.
- To ensure efficiency of the dosing system, it is necessary to regularly carry out the maintenance operations set out in the chapter "Maintenance" .
- The indications concerning the storage and disposal of chemical substances are provided by the respective manufacturers and must be observed.
- Do not place the chemical containers on the machine. Completely empty the washer disinfectant before performing maintenance and before moving the machine to avoid contact with the chemicals and to protect the machine components.

**5.6.2 USING AND STORING CHEMICALS**

Keep the containers tightly closed, stored in a dry place and protected from the sun, out of reach of children and outsiders. Possibly locked away. Optimal storage temperature: check the chemicals datasheet. The shelf life in the original containers is indicated on the chemicals' labels. The manufacturer recommends a method for inventory management (first in- first out). The washer disinfectant can use up to 4 products for dosing liquids.

The manufacturer recommends using cleaning agents and chemical additives. The use of other products can damage the machine.

The flow meters of chemicals are calibrated according to the density of these tested products which ensure correct operation.

The following combinations of process fluids have been tested to verify the compatibility of the materials with the components inside the device, for devices placed on the market starting from the 1<sup>st</sup> of April 2021.

When chemical levels are low, a warning message appears on the display.

Chemical products dosing is set to an average value as recommended by the manufacturer.

When the actual dosing of the chemical exceeds the tolerance of 5%, the system goes into alarm.



**WARNING!** Use only the chemical products recommended by the manufacturer, tested and validated in accordance with ISO EN 15883. The use of non-certified products will void the warranty.

The machine leaves the factory with the washing programs set for the use of the following validated chemical products:

<b>Manufacturer: TUTTNAUER</b>	
<b>Detergent</b>	T-Clean Tiva Detergent
<b>Neutralizer</b>	T-Clean Tiva Neutralizer



**WARNING!** If the machine does not use the liquids chosen in the machine configuration, the flow meters must be recalibrated for the new liquids.

## 6 USING THE MACHINE

Before starting the machine, the operator in charge must have read and understood this whole manual, in particular the information given in section «3 Safety and prevention».

Furthermore, before starting work, check that the machine is in order and that all parts subject to wear and deterioration are fully efficient.

### 6.1 COMMISSIONING INSTRUCTIONS

These control operations (reported below) are performed to check if the machine works properly and should be performed when the machine installation is completed.

1) Open the tap that supplies water to the machine.



**WARNING!** The water should NOT flow into the chamber; otherwise the water loading solenoid valves are dirty or blocked due to long storage in the warehouse and therefore they must be cleaned.



**WARNING!** Check that there are no water leaks in the pipe fittings.

- 2) Check that the suction tubes (located in the lower part of the machine) within the corresponding tanks containing the liquids provided (detergent, neutralizer, and/or others), are correctly inserted.
- 3) Using the main circuit breaker, supply power to the machine.
- 4) Check that the water supply flexible hoses are properly connected.
- 5) At the beginning of the first cycle check the level probes of the liquid suction tubes (detergent, neutralizer and/or others): pull one tube at a time out of the container and check if the corresponding alarm flashes on the display, indicating the need for liquid refilling.
- 6) After running 3-4 washing tests, clean the water filters placed in the lower compartment of the machine (Fig. 11).
- 7) Check that the drain trap does not show water leaks and is firmly secured to both the machine and the drain.
- 8) Check if the pumps correctly suck washing liquids. To do this, check that the liquid rises along the tube connected to them.

#### 6.1.1 LOADING THE CHEMICALS

When changing the tanks chemicals, it is required to perform the manual filling of the hydraulic circuit. This phase is important because it prevents any air bubbles present in the pipes from causing an interruption of the cycle following an incorrect reading of the flow meters.

To fill the pipes after changing or refilling the chemicals, proceed as follows:

- 1) Open the door using the “DOOR” button on the touch screen (4 Fig. 13), if the door is already open, leave it opened;
- 2) Remove the rack if inserted, in order to have full visibility of the washing chamber;
- 3) Press and hold the button corresponding to the dosing pump you wish to activate to manually load the hydraulic system: key P1 (1 Fig. 13) on the touch screen for pump DOS1; key P2 (2 Fig. 13) on the touch screen for pump DOS2; key P3 (3 Fig. 13) on the touch screen for pump DOS3; key P+ (4 Fig. 13) on the touch screen for pump DOS4.

- 4) Wait a few seconds to see in the lower right part, the area where the chemical inlet holes are present, a constant flow free from air bubbles.
- 5) Release the button and repeat the sequence from 3 to 4 for the other dosing pumps that need to recharge the hydraulic circuit.

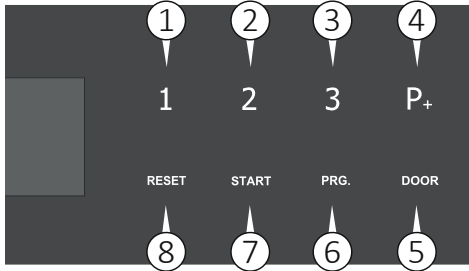

**Fig. 13**



**CAUTION!** This phase must be performed at the first installation of the machine, in this case, let the liquid flow for a few more seconds to ensure the correct and full loading of the hydraulic system.

## 6.2 BEFORE USE

The washer disinfector can be used for cleaning and disinfecting:

- medical and dental instruments;
- keys, trays, containers;
- hollow instruments, e.g. suction cannulas, fixing them to the appropriate supports, using the suitable adapters.

### 6.2.1 EMERGENCY DOOR RELEASE

In the event of a blackout, or any other need in which it becomes difficult to open the machine door, there is a manual emergency release that can only be activated if the door cannot be opened normally.



**HAZARD!** If the emergency release is used while a program is running, very hot water and chemicals may leak. Therefore, there is a danger of burns, scalding and irritation.



**HAZARD!** In the case of an emergency release of the door, the load might be contaminated. Be careful while handling it.

Release the door:

- 1) Push the key supplied in the pack horizontally into the gap between the door and the lid or worktop (1 Fig. 14.1), to position the key correctly, follow the position indicated on the label (1 Fig. 14.2) on the door handle.
- 2) Upon the door unlock take out the key.

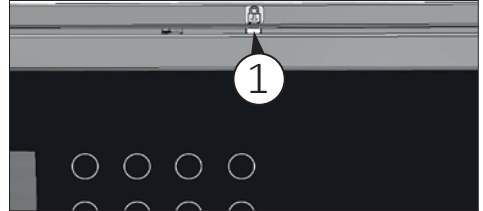

**Fig. 14.1**

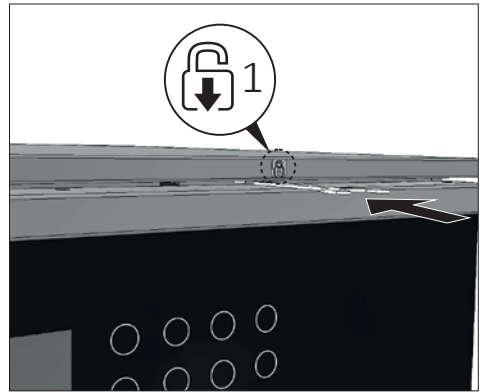

**Fig. 14.2**

In case of program interruption, proceed with a new treatment of the load.

### 6.2.2 PREPARING THE LOAD



**WARNING!** The maximum weight that the open door can withstand is 66 lbs (30 kg). The maximum volume of the wash chamber is 44 US gal (165 l).

- The instruments to be washed must be placed on the relative racks, making sure that they do not overlap one another.



**IMPORTANT NOTE!** The cleaning quality depends on the correct loading of the instruments.

- Empty any residual liquids from the instruments and containers before inserting them in the chamber,

- washing all residues well (e.g. disinfectant solutions) in cold water.
  - Remove non-water soluble residues such as composites, cement and amalgam in compliance with current directives.
  - Insert the individual instruments in the appropriate supports or baskets and never directly into the base basket.
  - If necessary rinse the wash load briefly with water to avoid introducing coarse soiling into the machine.
  - Remove all stoppers, corks, labels, sealing wash residue, etc.
  - Make sure that the instruments do not come out of the containers.
  - Make sure that the instruments do not fall off the racks and inserts and do not hang from the grid bars.
  - Insert the hollow instruments into the appropriate injectors.
  - Insert the other instruments into the adapters with silicone insert.
  - Check that injector and connectors are securely held in position in the baskets or inserts.
  - Position container-shaped objects so that liquids can flow easily and, if possible, place tall and heavy tools in the centre of the rack.
  - Place pointed or sharp objects in such a way as to prevent anyone from being injured by them.
- Carefully place the load in the supports.
  - Objects must not be put inside each other nor cover each other. Do not place objects so close to each other that they cannot be washed properly.
  - Arrange the load so that all surfaces can be reached by the washing liquid. Otherwise they will not be cleaned!
  - Place the objects so that the liquids can flow out without hindrance.
  - Tall, narrow, hollow and heavy items should be placed in the centre of the rack. This will ensure better water coverage.
  - When arranging the load, make sure that the spray arms are not blocked by the load itself.
  - After treatment, the transmission instruments must be cleaned according to the manufacturer's instructions. After treatment, before reusing the transmission instruments, check that they are working properly, e.g. by spraying liquids into the sink.



*WARNING! Sharp or pointed objects can result in serious injury when loading or unloading*

- Components with special geometries must be arranged so as to allow the water to flow out.
- Introduce only suitable steel instruments, resistant to corrosion.
- Objects made completely or partially of plastic must be resistant to high temperatures.
- Nickel-plated and chrome-plated and/or aluminium instruments and tools may not always be suitable for machine treatment. They require special process conditions.
- If possible, disassemble the modular instruments following the manufacturer's instructions and treat the individual parts separately.
- Transmission instruments with fibre optic rod are considered resistant, while fibre optic beams may be subject to premature wear.
- Treat small instruments and parts in special inserts or closable baskets.
- Before the automatic treatment, check that the lumen and hollow body instruments can be treated internally and remove any obstructions.

### 6.2.3 SUMMARY OF THE RACK LOADING OPERATIONS

Depending on the load, special nozzles or adapters may be required for proper internal cleaning.

Sequence for loading the rack/trolley:

- 1) Fill the rack/trolley by arranging the instruments so that all surfaces are reached during washing.
- 2) Insert the rack/trolley into the chamber.
- 3) Close the door and start the washing program.

#### Handpieces

Handpieces must be washed and rinsed both internally and externally. For this purpose, they require the use of racks/trolleys with special injections.

#### Trays

Trays must be positioned in the specific slots of the tray holder insert.

### 6.2.4 TREATMENT OF DENTAL INSTRUMENTS



*WARNING! Insert only instruments suitable for automatic treatment in washer disinfectors, according to the manufacturer's instructions. In particular, follow the information provided by the same manufacturer. Despite compliance with the manufacturer's instructions, in case of damage or alteration of the instruments, the responsibility will be borne by the instruments manufacturer.*

Before starting the treatment, check that:

- The external surface of the instruments is clean of material residues (E.g. dental cement, etc.).

- The air and spray channels must be clean.
- Finally, carry out a test.

Use the recommended liquids (see chapter "Using and Storing Chemicals").

### Care of the instruments

Major manufacturers recommend drying the spray/air/water channels immediately after cleaning and disinfection using clean compressed air with suitable maintenance products. It is recommended to follow the specific instructions.

### 6.2.5 TREATMENT OF OPHTHALMIC INSTRUMENTS



**WARNING!** Only insert instruments designed for automatic treatment in washer disinfectant. Carefully follow the instructions provided by the instrument manufacturer.



**HAZARD!** Do not insert instruments intended for interventions on the optic nerve and which come into contact with the retinal tissue.



**WARNING!** In case of damage or alteration of the instruments despite compliance with the manufacturer's instructions, the responsibility will still be borne by the instrument manufacturer.



**WARNING!** The treatment of ophthalmic instruments requires the use of deionized water.

Comply with the following for automatic treatment:

- Use a slightly alkaline detergent for cleaning. Use a citric acid-based neutraliser for neutralisation. Never use chemicals during the last rinse.
- Rinse the hollow instruments after the application and check that the deionized water passage is free before the automatic treatment.
- Insert the hollow instruments into the rinse bar, specially designed for this use.
- Make sure that no deposits form on the instruments.
- Dry the hollow instruments with compressed air after the treatment in order to remove all residual humidity.
- Follow the manufacturer's instructions with regard to the maintenance of instruments/accessories for loading.

## 6.3 PROGRAMS

The machine leaves the factory with presetting washing programs already entered in the settings menu.

*For programs details see the Washing Programs booklet.*

### 6.3.1 SUGGESTED PROGRAMS VS CONFIGURATIONS

For a good result, it's important to choose the right program together with the right load/configuration.

To select the programs available, use key P1, P2 or P3 (see Fig. 15) depending on the most suitable program for the level of dirt of the load.

### 6.3.2 PROGRAM STRUCTURE

- Drain: It is used to empty the washing chamber.
- Pre-wash: Pre-wash is necessary to eliminate coarse dirt and foamy substances.
- Wash: Depending on the load, washing normally takes place at 113°F- 149°F (45°C- 65°C), adding the appropriate detergent.
- Rinse: The rinsing operation eliminates and neutralises the chemicals of previous washes.
- Disinfection: Process to inactivate viable microorganisms to a level previously specified as being appropriate for a defined purpose, deionized water (if available) should be used during the disinfection phase.
- Drying: Sufficient drying reduces the risk of corrosion caused by the residual humidity on the load (not available for models without drying system).

## 6.4 STARTING THE MACHINE

After checking the integrity and full efficiency of the machine, proceed with start-up:

- Power the machine using the main circuit breaker.
- Open the door (key 5 Fig. 15) to introduce the rack.

### 6.4.1 BEFORE STARTING THE PROGRAM

Before starting each program, check:

- That the filters, positioned on the bottom of the chamber (Fig. 11) are perfectly clean. Clean them, if necessary.
- The nozzles of the upper and lower spray arms must be free and clean.
- Products must be arranged correctly.
- The spray arms must be able to rotate freely. The machine constantly monitors the rotation speed during the program (optional).
- Liquid containers must be sufficiently filled. Check for any messages on the display before starting the program.

### Closing the door

- Load the instruments and introduce the rack.



- Close the door and push it until the lock is activated. The door can be unlocked and opened at any time before the program starts, by pressing the DOOR key (5 Fig. 15).

### Selecting the program

To select the programs available, use key P1, P2, P3 or the key P+ (to select programs from 4 to 40) on the control panel (Fig. 15).

## 6.4.2 STARTING THE PROGRAM



**WARNING!** Always follow the indicated procedures. Inattentive and frivolous use of electrical devices may lead to risks for the operator.

The manufacturer is not liable for possible damage caused by uncontrolled use of the device.

After selecting the program with relative key, the display shows the selected program and the operating time and temperature.

To start a program, press the START key (7 Fig. 15).

Time counter use the first cycle to self calculate the time for each cycle.

### Program execution

Once the program has started, its progress can be followed on the display. The display shows the program phases during operations.



**WARNING!** The program can be interrupted at any time. However, it must be remembered that once interrupted, it must restart from the beginning. Only if it is interrupted in the drying phase can the cycle be considered completed successfully. The instruments must be dried.



**WARNING!** In case of contact with the fluids inside the chamber after the cycle has been interrupted before the end of the disinfection phase and consequent opening of the door, immediately contact the nearest health center.

### Pre-wash

Pre-wash is carried out with cold water (optional softened water) and without liquids. It mechanically dissolves encrusted organic materials and all proteins on the surface of the instruments. Avoid too high water temperatures.

### Wash

It is the actual cleaning cycle. The cleaning chamber heats up until it reaches the specific temperature for the selected program, a temperature that remains stable for the holding time. The cleaning liquid is automatically introduced before the start of the holding time.

### Rinse

Rinsing is carried out with cold water, the machine is standard equipped with the second pump with which it is possible to carry out the neutralisation cycle by introducing neutralising liquid which is designed to reduce the alkalinity and clean the instruments from residues soluble in acid, e.g. limestone and rust.

### Disinfection

Thermo-disinfection is carried out with deionised water, depending on the setup of the machine, it is possible to introduce the rinse aid to improve the drying phase.

### Drying

The instruments are dried internally and externally with filtered hot air. Good drying reduces the risk of corrosion caused by the residual humidity on the load. Instruments with a very small internal diameter must be dried further.



**WARNING!** If the drying phase is disabled, the machine will interrupt the cycle at the end of the rinse phase. It is the responsibility of the user to dry the instruments that have just been washed, using suitable cloths and following the instructions contained in the instruction manual for each individual instruments washed.



**WARNING!** If the drying phase is disabled, the instruments must NOT be left inside the machine, at the end of the cycle, wet, for longer than 5 minutes. This is to prevent the proliferation of bacteria and microorganisms. The manufacturer declines any liability for contamination of the instruments during the manual drying stage.

## 6.4.3 PROGRAM END

The message «Finish» with a green background on the display indicates that the program has been carried out correctly. Unlock the door by pressing the DOOR key (5 Fig. 15) and open it.

⇒ *IMPORTANT NOTE! Open the door immediately after the end of the program to avoid condensation forming.*

Check the results at the end of the cleaning process. The instruments must be completely clean and dry.

⇒ *IMPORTANT NOTE! Hollow instruments with a small internal diameter must be dried further with air.*

- Check hollow instruments and retreat them if necessary. The hole (lumen) of hollow instruments must be free.
- The injectors must be correctly placed on the connection tube in the cleaning chamber.
- The nozzles and connections to the base grid must be firmly fixed.

If these checks are positive and the program has been carried out without interruptions or malfunctions, the load has been successfully cleaned and disinfected.

#### 6.4.4 EXTRACTING THE LOAD

At the end of the program and when extracting the load:

- Do not force the door open to avoid damaging the device or creating a hazardous condition.



*WARNING! Particularly large instruments can be very hot at the end of the program. Allow instruments to cool down before removing them. Use adequate gloves that protects against burns.*



*WARNING! Failure to follow these recommendations can cause burns.*

## 7 CONTROL PANEL

The control panel consists of 8 keys and a 3.5 inch LCD display. All keys, except key "3", are multi-function, depending on the action being performed in a specified state of the device.

Here below the description of the control panel standard (STD) and special (SPC) functions. Later on, with the description of how the machine works, we will find these symbols again.



*IMPORTANT NOTE! "User Pin Management" option on request. The special functions (SPC) related to the username and password settings for the USER are not available if the option is not enable.*

### 1) P1

- STD: select program 1;
- SPC: "1" character for the custom password;
- SPC: navigate upward in the menu;
- SPC: change the value of the highlighted parameter.

### 2) P2

- STD: select program 2;
- SPC: "2" character for the custom password;
- SPC: navigate forward in the menu;
- SPC: change the value of the highlighted parameter.

### 3) P3

- STD: select program 3;
- SPC: "3" character for the custom password;

### 4) P+

- STD: select the next program (proceeding by +1 at a time upon program 40);
- SPC: delete incorrectly typed field.

### 5) DOOR

- STD: open the door at the end of the program;
- SPC: exit from parameters and programs.

### 6) PRG

- STD: enter to the program menu;
- SPC: "C" character for the custom password.

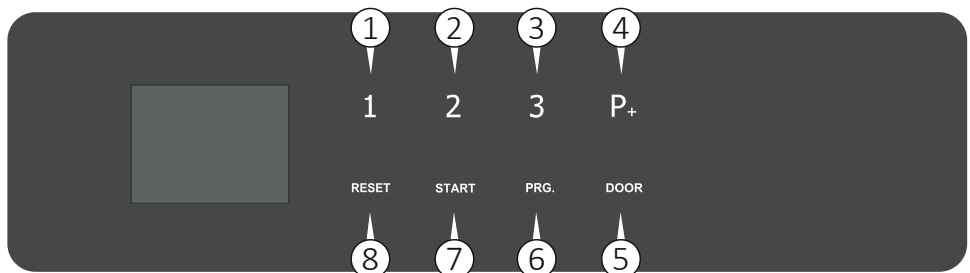

**Fig. 15**

**7) START**

- STD: enter the selected menu item;
- SPC: continue to the next parameter;
- SPC: "B" character for the custom password.

**8) RESET**

- STD: stop a running program;
- SPC: return to the previous menu item;
- SPC: "A" character for the custom password.

**7.1 COLORS OF THE KEYS**

Depending on the menu function you are using, the keys get highlighted with different colors:

- White light: indicates the keys that can be used in that particular action.
- Red light: indicates the function "go back to the previous menu" if associated with the DOOR key; indicates the function "delete the characters typed" if associated with the P+ key.
- Green light: indicates confirmation of the action.



On any screen and for any action you can only use the highlighted keys.

**7.2 DISPLAY**

The LCD display shows the status of the machine. The images show the various phases and the current operation. For example: if the machine is loading water, the display will show the image of the tap, of the water flow meter and of the water being loaded. If water is cold, droplets will be blue and if water is hot, they will be red. The temperatures are set in degrees Celsius or Fahrenheit. The images are animated, to show how the current operation evolves.

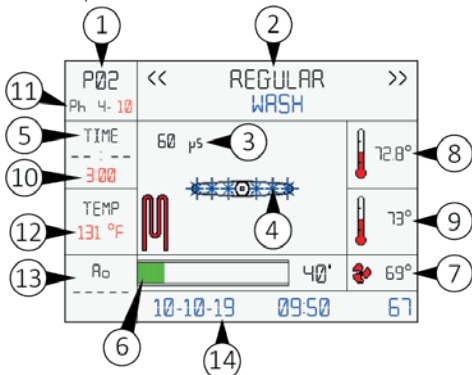

Fig. 16

**Description of the display (Fig. 16):**

- 1) The number of the running program is displayed (e.g. P02 = program 2);
- 2) It displays the phase the machine is running. If the machine is going to run a wash cycle it will display the writing «Wash». When the machine displays an alarm that space background turns red and the message shows the number of the alarm and a brief description;
- 3) Water conductivity value in microsiemens (if conductivity probe function is enabled);
- 4) Several animated images showing the current status of the machine are displayed;
- 5) The elapsed phase time from the moment the temperature set for the phase (see 12) has been reached is displayed;
- 6) Bar indicating the progress of the program; if the program is ending, the bar will be almost entirely green;
- 7) The temperature measured by the PT1000 probe, placed after the air heater, is displayed to indicate the temperature of the air entering the chamber;
- 8) It displays the temperature measured by the first PT1000 probe placed in the chamber;
- 9) It is the display of the temperature measured by the second PT1000 probe placed in the chamber. The temperature detectable by the two probes must not differ from each other by more than 36°F (2°C);
- 10) Time for which the device should maintain the set temperature (see 12);
- 11) Phase of the program;
- 12) Temperature set for the current phase;
- 13) The A<sub>0</sub> value is displayed during disinfection;
- 14) Date and time are displayed with the machine in stand-by.

**7.2.1 MESSAGES ON THE DISPLAY**

On the display of rack insertion, messages may be displayed, such as:

- Product 1 liquid reserve: meaning that the liquid inside the product 1 tank is finishing and must be replaced;
- Product 2 liquid reserve: meaning that the liquid inside the product 2 tank is finishing and must be replaced.

When the cycle has finished the following message appears: «Finish» and a green light appears in the chamber. At this point the door is unlocked and you can unload the rack with the washed items.

**7.2.2 BLUETOOTH ENABLED**

If bluetooth is enabled, the following icon will appear on some display screens:



Fig. 17.1

If bluetooth has been disabled the following icon will be displayed:



Fig. 17.2

For more information on bluetooth, see chapter "Bluetooth".

### 7.2.3 DISPLAY SCREENS

After starting the machine, following the instructions in chapter "Starting the Machine", the display will show the images indicating step-by-step the operations in progress.

- 1) Once the machine has started, the display shows the screen indicating door open and the invitation to insert the rack with the instruments to be washed. Then insert the rack with the instruments and close the door.



**WARNING!** The door must be tightly closed until you hear the classic closing «click», otherwise the program will not start.

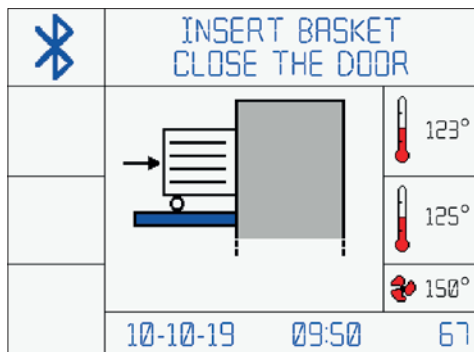

Fig. 18.1

- 2) With the machine started and door closed, the screen for selecting the programs will appear. Press the selected key (P1 or P2 or P3 Fig. 13) on the control panel. To access subsequent programs (if stored), press the key «P+» several times.

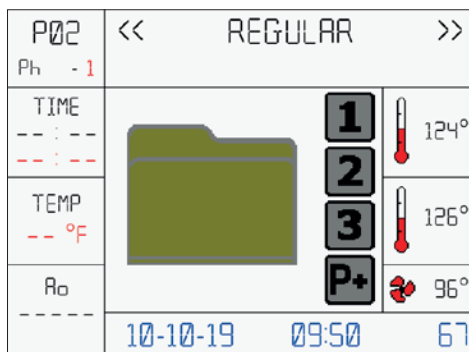

Fig. 18.2

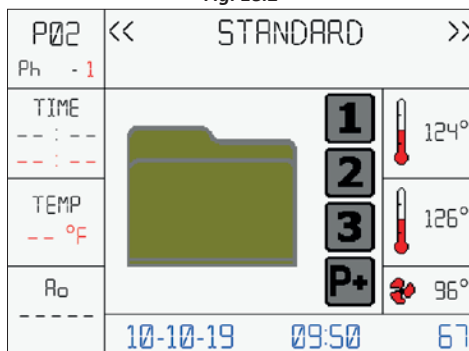

Fig. 18.3

- 3) Optional: once the program is selected, the screen for selecting the user will appear. Press the key P1 or P2 on the control panel to navigate upward and forward in the user list. Then press START.

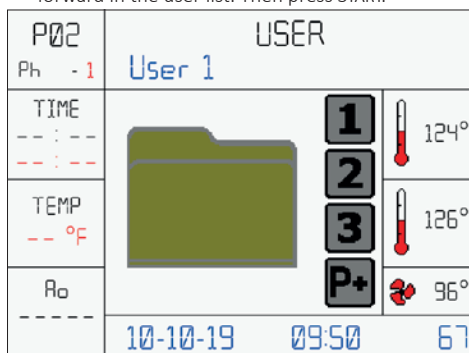

Fig. 18.4

- 4) Optional: enter the user password: use the key P1, P2, P3, RESET, START and PRG on the control panel to digit the correct password (See Fig. 13 for key description).

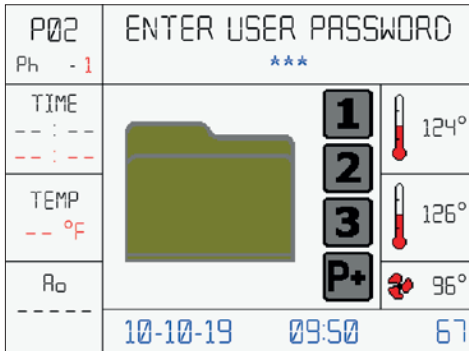

Fig. 18.5

**7.2.4 PROGRAM 2 REGULAR**

**Phase 1**

5) The machine starts the automatic work cycle and discharges any residual water present in the chamber.

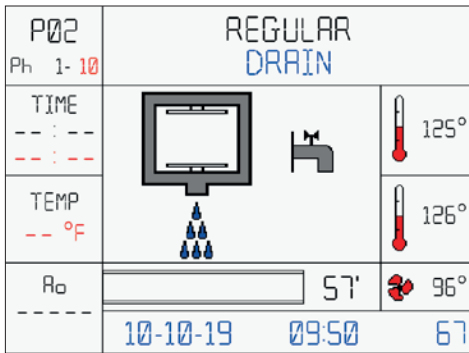

Fig. 18.6

**Phase 2**

6) Self-loading of cold water. During the self-loading phase the chamber will be filled.

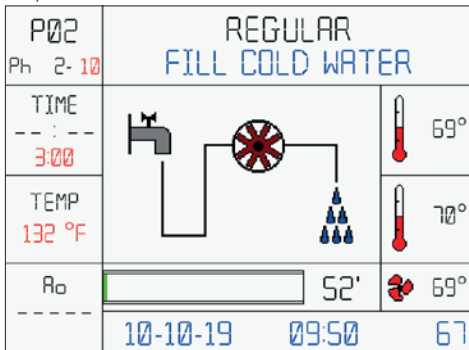

Fig. 18.7

7) Prewash phase begins.

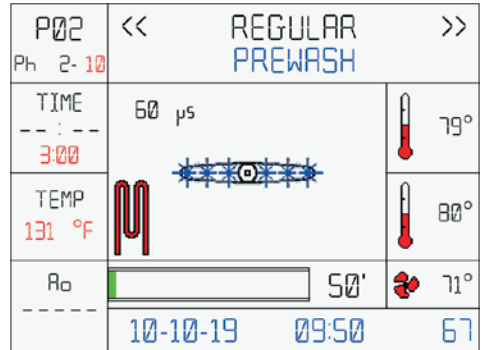

Fig. 18.8

**Phase 3**

8) At the end of the prewash phase, the water is automatically discharged.

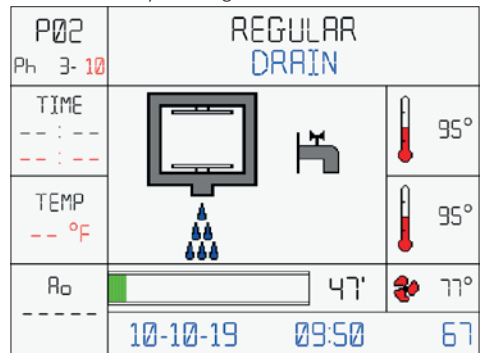

Fig. 18.9

**Phase 4**

9) Self-loading of hot water. During the self-loading phase the chamber will be filled.

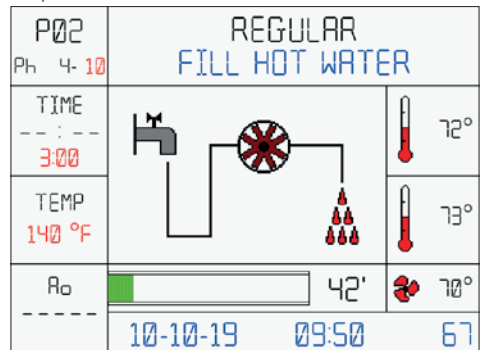

Fig. 18.10

10) Wash phase begins: the machine will rise the water temperature to the presetted value and will keep it for the presetted time.

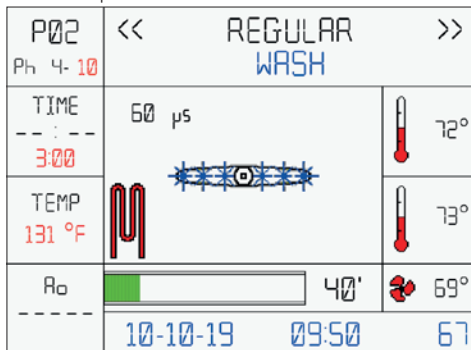

Fig. 18.11

11) When the water reaches the 35°C (95°F), the peristaltic pump 1 will dose the detergent.

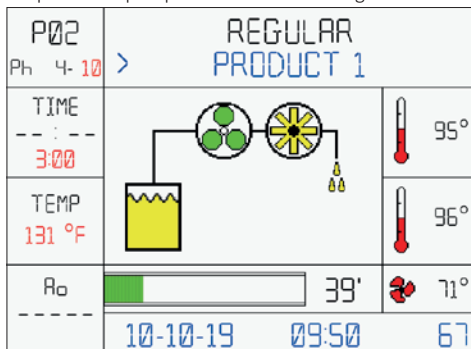

Fig. 18.12

**Phase 5**

12) At the end of the wash phase, the water is automatically discharged.

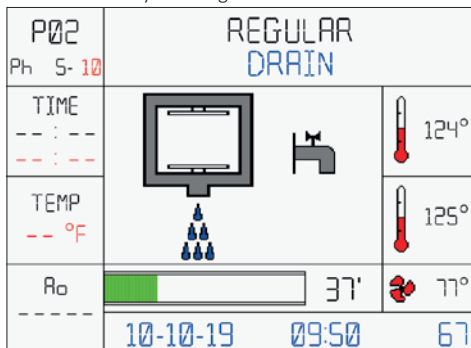

Fig. 18.13

**Phase 6**

13) Self-loading of hot water. During the self-loading phase the chamber will be filled.

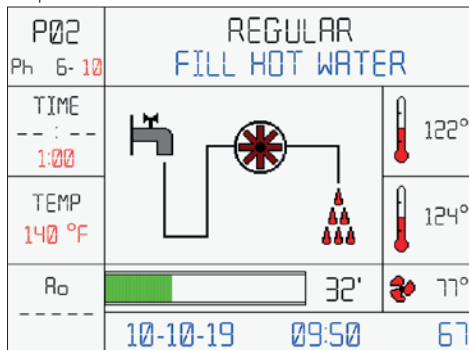

Fig. 18.14

14) Rinse phase begins: the machine will rise the water temperature to the presetted value and will keep it for the presetted time.

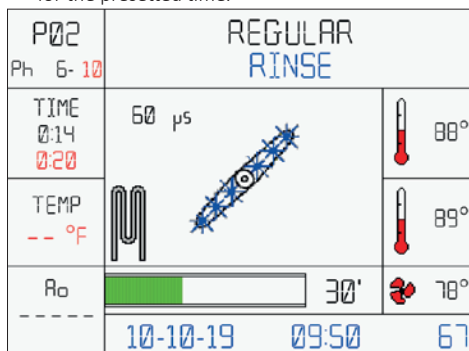

Fig. 18.15

15) When the water reaches the 35°C (95°F), the peristaltic pump 2 will dose the neutralizing agent.

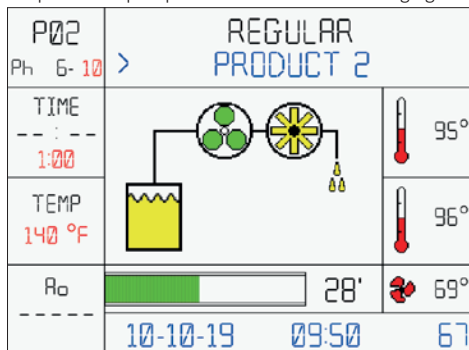

Fig. 18.16

**Phase 7**

16) At the end of the rinse phase, the water is automatically discharged.

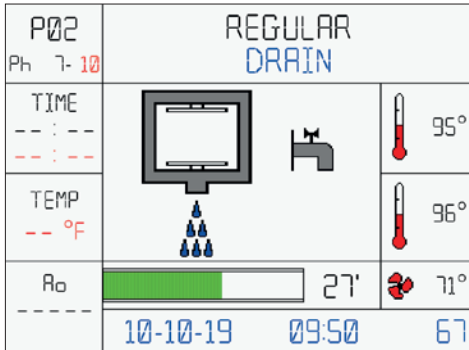

Fig. 18.17

**Phase 8**

17) Self-loading of deionized water. During the self-loading phase the chamber will be filled.

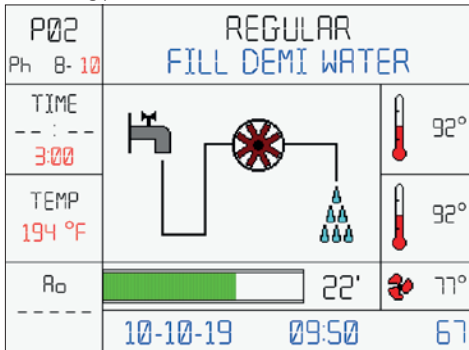

Fig. 18.18

18) Rinse phase begins: the machine will rinse the instruments while checking the conductivity of the water. At the end of the phase, if the conductivity will be below a presetted value, the machine will proceed to the next phase. If the check is negative, the machine will repeat phases 7 and 8 again. If the second check will fail, the machine will show an error and stop the cycle.

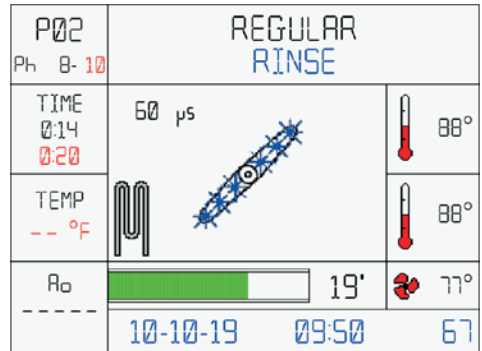

Fig. 18.19

19) Disinfection phase begins: the machine will rise the water temperature to 194°F (90°C) and will keep it for 5 minutes.

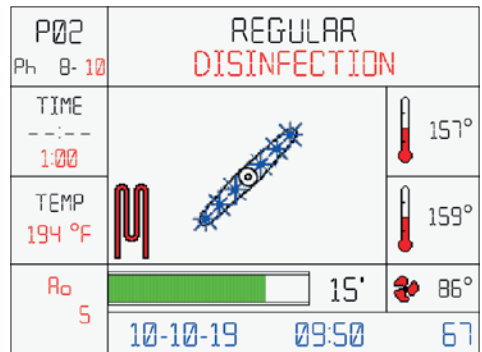

Fig. 18.20

**Phase 9**

20) At the end of the disinfection phase, the water is automatically discharged.

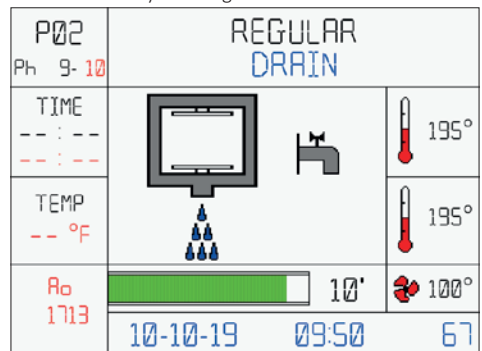
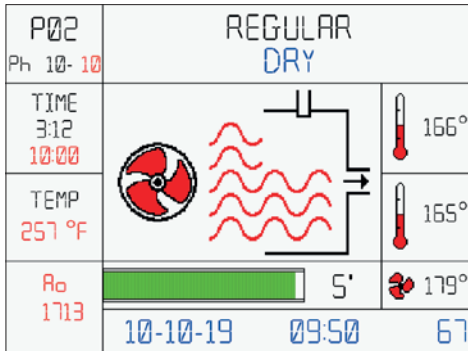

Fig. 18.21

**Phase 10**

21) Dry phase begins: hot air is blown inside the chamber at a preset temperature and kept for the preset time.



**Fig. 18.22**

22) End of the «REGULAR» cycle. Open the door and remove the rack.

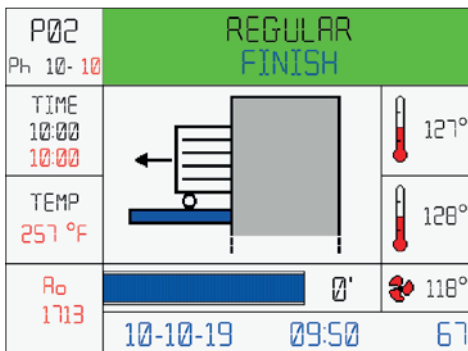

**Fig. 18.23**

If, for any reason, it is necessary to interrupt the cycle, simply hold down the RESET key for a few seconds until an audible alarm (buzzer) is heard and an alarm screen appears on the display.

Once the problem is resolved, resume the cycle from the beginning. If the problem cannot be solved, contact the technical assistance.

**7.2.5 ALARM MESSAGES**

The machine is equipped with an alarm system that indicates malfunctions detectable with an audible signal (buzzer), a screen on the graphic display of the control panel and a red led light in the chamber.

At first the image concerning the alarm is displayed (for 5 seconds); then the alarm description is displayed (for 10 seconds).

The image and text alternate until the alarm is reset.

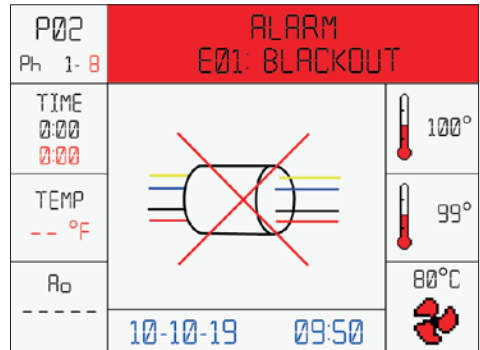

**Fig. 19**

If the program is interrupted because of an alarm, the display will show the message «No disinfection stop-alarm». Follow the message shown on the display to reset the alarm.



**IMPORTANT NOTE!** If the RESET button is pressed during the wash cycle, the program is interrupted and an alarm is displayed with the message «No disinfection stop - user». Press RESET to return to initial display.

For the alarms, description and possible solutions see Annex 12.6.

**7.2.6 USER SETTINGS MENU**

Start screen

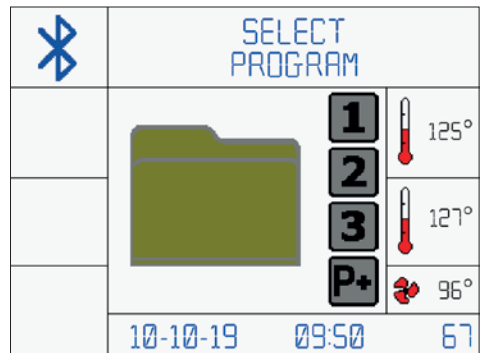

**Fig. 20.1**

To access the settings menu the procedure is as follows: Open door -> PRG key for 5 seconds-> If the user and password are enabled, insert user password.



**IMPORTANT NOTE!** "User Pin Management" option on request.



The keys and their operation are shown below, contextualised according the menu in which you are located:

- Use P1 and P2 to navigate up and down the menu.
- Press START to access the entry of the menu selected.
- Within the parameter, use the P1 and P2 keys to change the value of the highlighted parameter.
- Press START to go to the next parameter.
- Press PRG to return to the previous menu.

PROGRAMMING		
Insert password		170°
**		170°
		118°
10-10-19 09:50		67

Fig. 20.2

The menu consists of two screens, the item, when selected, lights up:

SETTINGS		
GENERAL		170°
TEMPERATURES		170°
TIMES		170°
PUMPS		118°
REGENERATION		
CONDUCTIVITY PROBE		
CLOCK		
CYCLES COUNTER		
USER PIN		
PRINT LAST CYCLE		
10-10-19 09:50		67

Fig. 20.3

SETTINGS		
BOILER		170°
		170°
		118°
10-10-19 09:50		67

Fig. 20.4

### 7.2.7 SETTINGS

See Annexes 12.1 and 12.2.

### 7.2.8 LANGUAGE SETUP

To change the display language, with the door open, press PRG for 5 seconds and enter the Super User password. Once the menu appears, press the START button under GENERAL. Scroll to the “Display Language” setting and select the desired language from those available.

### 7.2.9 USB KEY MANAGEMENT

When the USB key is hooked up in the machine, the following message appears after a few seconds:

P02	SAVING DATA		
Ph - 1	Wait ...	46%	
TIME		1	170°
---		2	170°
---		3	170°
TEMP		P+	118°
---			
10-10-19 09:50		67	

Fig. 21.1

When the USB key is removed from the machine, after a few seconds the following message appears.

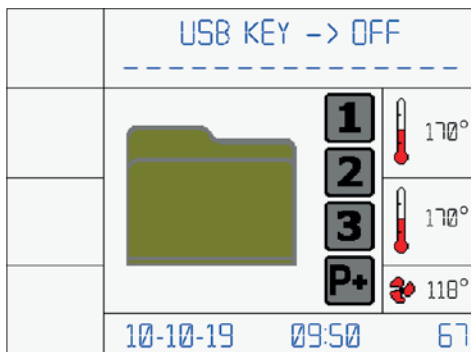

**Fig. 21.2**

Use USB 2.0 only, system does not support USB 3.0.

### 7.2.10 PROCEDURE FOR PASSWORD CHANGE

To generate the password use the keys P1, P2, P3, RESET, START and PRG (See Fig. 15 for key description). Entering the password incorrectly three times in a row will cause the block of the user.

See Annex 12.3.

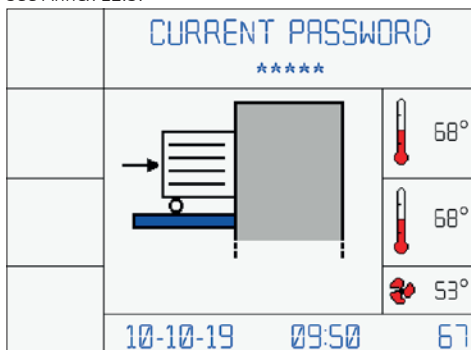

**Fig. 22**

### 7.2.11 EXPIRING PASSWORDS

#### User password

- Has a preset validity of 6 months, after the expiring date, it must be renewed. At first access it must be generated by the Super User. See Annex 12.3 for the procedure for password change. See Annex 12.4 for the procedure for user password setup for the Super User. This option is available if the *USER PIN MANAGEMENT* is enable.

#### Super User password

- At the first access enter the password "111111". As for the User, the Super User password has a preset validity of 6 months, after the expiring date, it must be renewed. See Annex 12.5.

## 7.3 ALARMS

See Annex 12.6.

## 7.4 WARNINGS

See Annex 12.7.

## 8 SOFTWARE DESKTOP

### 8.1 GENERAL INFORMATIONS

On request, the washer disinfecter comes with a desktop software, called "WasherRePortal", that gives enhanced features to the User. With this software, in fact, it's possible to:

- create and print digital versions of the reports;
- connect the device to the PC to customize the user names and passwords via USB port (cable not included; use USB 2.0 only, system does not support USB 3.0);
- save the information coming from multiple devices;
- import and export the database of reports;
- export comma separated value files (\*.CSV) for post-processing activities (free files editables with third-part softwares like MS Excel).



**IMPORTANT NOTE!** The software comes with a free one week (7 days) trial period, at the end of the trial period you must contact your dealer or distributor to enter the activation code to continue using the software.

If you have the software, please refer to the user manual for more information regarding the use.

### 8.2 BLUETOOTH

The washer disinfecter can be equipped with bluetooth card that allows, through the use of the "RePortal" app, to download a .DTA file or export a PDF file on your device (equipped with bluetooth technology), containing all the information about the cycles performed by the machine.

The .DTA file can be opened with the "Washer RePortal" software to view all the informations and export the reports to your computer.



**IMPORTANT NOTE!** It is not possible to have USB and bluetooth technology together. If Bluetooth is present, USB is not available.

## 9 PLUGS

### 9.1 USB PLUGS

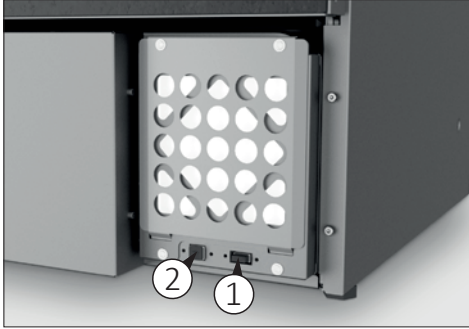

**Fig. 24**

Two different types of USB are present:

- 1) USB type A for pen-drive: see chapter "USB Key Management".
- 2) USB type B is used to connect an external PC.

### 9.2 RS232 PORT

The RS232 port is used for printer or data transfert to an external PC (LAN protocol). Depending on the configuration of the device (contact the manufacturer for information) the RS232 port may not be available for LAN protocol.

#### 9.2.1 LAN NETWORK COMMUNICATION VIA RS232

The following data are transmitted every second from the micro board (RS232 connector) to the modem that will manage them. These data are sent constantly (even if the device is in stand-by mode).

Serial protocol:

- Baudrate: 19200.
- Data bits: 8.
- Parity: None.
- Stop bits: 1.
- Flow control: None.

See annex 12.10.

- **PRG - Selected program:** The code of a program stay active until that program is finished. When the program is over, the code goes back to 0000. If an alarm is triggered and the machine is set to go back to standby mode after the alarm has been reset, the code goes back to 0000.
- **PHA - Current phase:** The code of the phase the machine is performing is updated every time a phase change occurs.
- **TPT1, TPT2:** The PT1000 1 probe is the work probe of the chamber, the PT1000 2 probe is the control probe of the chamber. The value increases by 0.1°C

at a time.

- **TPT3:** The PT1000 3 probe is the probe for air heater. The value increases by 1°C at a time.
- **ERR - Alarms:** 0000 means that the machine is not in an alarm state. When an alarm is triggered, its code will be transmitted until the alarm is reset.
- **CYC - Programs executed counter:** This is the counter of the programs the machine has performed.
- **REMT - Program remaining time:** Time remaining (in minutes) to cycle completion. When an alarm is triggered, this code is reset after the alarm is reset. When the device is in stand by, the code 0000 is transmitted.
- **PRP - Washing pump pressure:** Transmits the status of the wash pump.
- **VDP1, VDP2, VDP3, VDP4, VDP5 - Quantity of product delivered:** This code is reset every time a phase of the program ends.
- **VCW, VHW, VDW - Quantity of water delivered:** This code is reset every time a phase of the program ends.
- **COMP - Conductivity probe:** Transmits the status of the conductivity probe.
- **A<sub>0</sub> Value:** The A<sub>0</sub> code can go up to 99999 and is maintained until the program ends (like the A<sub>0</sub> value on the display). If an error occurs, the A<sub>0</sub> value is reset after resetting the alarm. If a program has more than one disinfection phases, this code is reset whenever a disinfection phase starts.
- **SPRYR.B, SPRYR.1, SPRYR.2, SPRYR.3, SPRYR.4, SPRYR.5, SPRYR.A - Spray arm rotation monitoring:** The value of rotations per minute of the spray arm is transmitted. If an alarm is triggered this value is reset after alarm reset.
- **CHPRS:** In the case of a machine equipped with a pressure transducer on the chamber pump, this value is transmitted.
- **TRPRS:** In the case of a machine equipped with a pressure transducer on the trolley pump, this value is transmitted.

## 10 LOADING THE PRINTER PAPER ROLL

To change the paper roll, proceed as follows:

- 1) Open the printer cover lever in on the cover lateral projections.

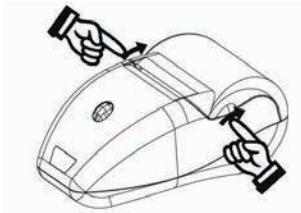

**Fig. 25.1**

- 2) Position the paper roll so that it unrolls in the direction shown.

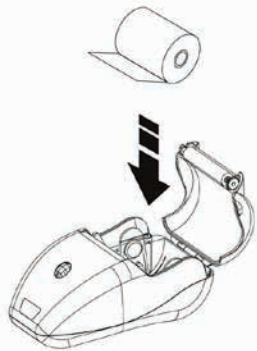

**Fig. 25.2**

- 3) Pull up on the edge of the paper and close the cover.

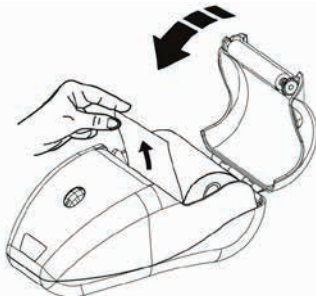

**Fig. 25.3**

- 4) Remove the excess paper. Switch-off and switch-on the machine. The printer is now ready.

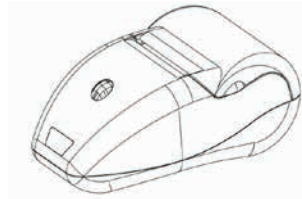

**Fig. 25.4**

## 11 MAINTENANCE

### 11.1 GENERAL INFORMATION

Maintenance is a set of periodic and predefined operations aimed at maintaining the machine functionality in all its aspects as a result of intrinsic wear and use.

It should be remembered that the lower operating cost and a long life of the machine depend on the continuous observance of what is reported in this manual.

---

**△ WARNING!** *The washer disinfector maintenance operations must be carried out with the machine completely switched off.*

---

**△ WARNING!** *If the machine is not used for more than 24 hours it is necessary to run a "Regular" washing cycle, without any instrument inside.*

---

The routine maintenance operations and the frequency of maintenance are described in the Maintenance Logbook.

The Maintenance Logbook is an integral part of this manual. If the Maintenance Logbook is missing, contact your dealer or distributor.

---

**△ WARNING!** *It is the user's obligation to fill in and keep updated the Maintenance Logbook. The incorrect or incomplete compilation of the Maintenance Logbook will void the warranty.*

---

### 11.1.1 PERIODIC MAINTENANCE REQUEST

After a certain time or a certain number of operating hours, the display shows «MAINTENANCE». This signal has no influence on the machine operation, contact the customer service or the dedicated technical assistance for periodic maintenance.



**WARNING!** Periodic maintenance is carried out by the technician under guarantee only if the user has correctly and regularly carried out all ordinary maintenance operations and if the user has filled out and kept up-to-date the Maintenance Logbook.

### 11.1.2 PERSONAL PROTECTIVE EQUIPMENT (PPE)

The operator engaged in this type of intervention must wear PPE and must be sure that no other unauthorised person is present in the operating area of the machine. Before maintenance, start a program to wash the washing chamber.

### 11.1.3 CLEANING PRODUCTS

Clean the outside of the machine with products suitable for stainless steel, glass and plastic materials.



**HAZARD!** Products unsuitable for cleaning stainless steel, glass and plastic materials may irreparably damage non-interchangeable parts of the appliance and render the machine unusable.

If a suitable cleaning liquid is not available, a mixture of water (75%) and alcohol (25%) may be used. Cleaning should be carried out with a smooth (non-scratchy) cloth moistened with the appropriate liquid.



**WARNING!** Do not spray the machine or near it with water jets, or with pressure devices.



**HAZARD!** DO NOT SOAK THE CLOTH to prevent excess liquid from entering electrically hazardous areas for the operator.

The keypad and display should be cleaned with a mixture of water and alcohol or with mild detergents. For cleaning the washing chamber, start a rinsing cycle without instruments.



**WARNING!** Do not use steel wool, steel brushes, bleach (bleach cause the oxidation of the stainless steel surface and consequent change of color) or any cleaning agent containing bleach or anything abrasive to cleaning the device. Doing so will damage the device!

## 11.2 ROUTINE MAINTENANCE

Routine maintenance operations are performed by the user and includes all those jobs needed to keep the machine clean and functioning. It is mandatory to perform these operations regularly or when necessary and the user is responsible for verifying their regularity. For routine maintenance operations refer to the Maintenance Logbook provided in the machine's pack.



**WARNING!** It is the user's obligation to fill in the Maintenance Logbook correctly and regularly. The incorrect or incomplete compilation of the Maintenance Logbook will void the warranty.

### 11.2.1 CLEANING THE CHAMBER FILTERS

Proceed as follows to clean the filters in the wash chamber:

- 1) Open the door and remove the load rack.



**HAZARD!** Very hot surfaces



**HAZARD!** Risk of injury: Be careful with sharp and pointed objects, which are withheld in the racks.

- 2) Remove the central filter (1 Fig. 11).
- 3) Remove the mesh filter (2 Fig. 11).
- 4) Remove the chamber bottom filter (3 Fig. 11).
- 5) Carefully clean the filters and remove the residual substances.
- 6) Remove the deposits from the drain and clean the drain.
- 7) At the end of the cleaning operations, refit the filters in succession.



**WARNING!** It is mandatory to record the weekly chamber filters cleaning in the Maintenance Logbook. Daily cleaning is also recommended to ensure continuous optimal operation.

### 11.2.2 CLEANING THE SPRAY ARMS

Clean the spray arms as follows:

- 1) Open the door and remove the load supports.



**HAZARD!** Very hot surfaces.

- 2) Loosen and remove both spray arms.
- 3) Rinse the spray arms thoroughly.
- 4) Reassemble and tighten in position the spray arms.

 **WARNING!** It is mandatory to record the weekly spray arms cleaning in the Maintenance Logbook. Daily cleaning is also recommended to ensure continuous optimal operation.

### 11.2.3 CLEANING THE AIR SUCTION FILTER

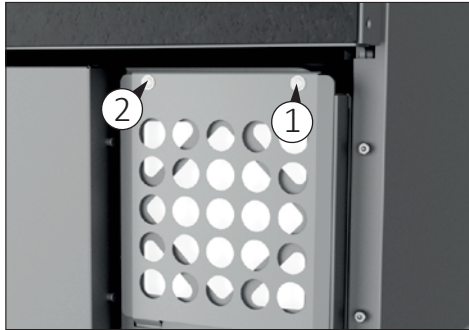

**Fig. 26**

- 1) Remove the filter cover panel (5 Fig. 2.1 and Fig. 2.2).
- 2) Unscrew the screws (1 and 2 Fig. 26) using a Torx screwdriver T20.
- 3) Pull out the prefilter.
- 4) Clean the prefilter with compressed air or cold water and dry the prefilter completely.

 **WARNING!** Reassemble the prefilter only once it is completely dry. If it is not completely dry it can damage the device.

- 5) Reassemble the completely dry prefilter.
- 6) Retighten the screws and refit the filter cover panel.

 **WARNING!** It is mandatory to record the monthly air suction filter cleaning in the Maintenance Logbook, to ensure continuous optimal operation.

### 11.2.4 REPLACING THE AIR SUCTION FILTER

The washer disinfecter is standard equipped with a suction filter for drying air.

The machine is also standard equipped with an «absolute» «HEPA H14» class supplementary air filter,

in compliance with EN 1822.

 **WARNING!** It is mandatory to replace the prefilter and the HEPA H14 filter as indicated in the Maintenance Logbook. In case of intensive use of the machine it is recommended to increase the frequency of maintenance.

When replacing the air suction filter use a Torx screwdriver T20 to open the filter panel.

### 11.3 SPECIAL MAINTENANCE

Special maintenance operations are not foreseen by the user but must be performed exclusively by the technical assistance or by an authorised and qualified service personnel that must refer to the Service Manual.

How to carry out special maintenance operations and the frequency of maintenance are described in the Service Manual.

**Contact the Manufacturer service for special maintenance.**

 **WARNING!** Special maintenance is carried out by the technician under guarantee only if the user has correctly and regularly carried out all ordinary maintenance operations and if the user has filled out and kept up-to-date the Maintenance Logbook.

### 11.4 TROUBLESHOOTING

The annex 12.8 lists the main malfunctions, with relative causes and recommended solutions, that the machine may present during its operation.

The interventions that may become necessary must be carried out by experienced and qualified operators.

If the problems persist or appear even more often after performing the work reported below, contact the technical assistance or an authorised and qualified service personnel.

## 11.5 EQUIPMENT DISPOSAL

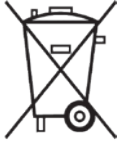

Respect the laws in force in the country of use of the machine, in relation to the use and disposal of the products used for the cleaning and maintenance of the machine, as well as observe what the manufacturer of these products recommends.

When disposing of a washer disinfectant, it is necessary to remember that it can still be contaminated by blood and other organic liquids, pathogenic germs, genetically modified material, toxic or carcinogenic substances, heavy metals, etc. and, therefore, it must be decontaminated before its disposal.

For safety and environmental protection reasons, dispose of all chemical residues in compliance with applicable legislation. When performing this operation, use protective goggles and gloves. Remove or disengage the door lock so that no one can get closed inside the machine, e.g. children playing. Finally, deliver the machine to a suitable and authorised collection centre.

The electrical and electronic devices to be disposed of contain reusable materials.

They also contain components harmful for the environment, but necessary for the correct operation and safety of the equipment. If they are not disposed of correctly or are disposed of as household waste, these components can damage human health and the environment. Never dispose of the old washer disinfectant among conventional waste.

Unauthorised product disposal by the user entails the application of very strict administrative sanctions provided for by current legislation. Enquire about this at your local dealer. Depending on the country in which one resides and the regulations in force, one is obliged to delete the data referring to people and stored on the machine.

**Finally, make sure that the old equipment is kept out of reach of children until its actual disposal.**

## 11.6 SPARE PARTS

The various components of the machine can be requested directly to the manufacturer by providing the following data:

- **Model, serial number and year of construction of the machine.** These data are stamped on the identification plate fitted on each individual machine.

- **Description of the part and required quantity.**
- **Shipping method.** If this item is not specified, the manufacturer, although dedicating particular care to this service, is not liable for any shipping delays due to force majeure. Shipping costs are always charged to the recipient. Goods travel at the risk and danger of the customer, even if sold carriage free.

**Finally, please note that the manufacturer is always available for any assistance and/or spare parts.**

## 12 ANNEXES

### 12.1 MENU PARAMETER TABLE

ID	Parameter Name	Min	Max	Description	Factory Default
<b>GENERAL</b>					
1	End cycle buzzer	0=OFF	1=ON	Turns the buzzer on or off at the end of a cycle	ON
2	Warning alarm buzzer	0=OFF	1=ON	Turns the buzzer on or off when an alarm is triggered	ON
3	Buttons noise	0=OFF	1=ON	Turns the noise on or off when a button is pressed	ON
4	Device 1	0= NONE 1= PRINTER	2= LAN	Enables or disables the printer (if present)	NONE
5	Device 2	0= NONE	1= KEY USB	Enables or disables the data storage feature on USB stick	KEY USB
6	Deionized water enable	0=OFF	1=ON	Enables or disables deionized water. If deionized water is enabled, hot water is automatically deactivated, and vice-versa	ON
7	Hot water enable	0=OFF	1=ON	Enables or disables hot water. If hot water is enabled, purified water is automatically deactivated, and vice-versa	OFF
8	User PIN enable at the start of cycle	0=OFF	1=ON	Available only with "User PIN Management" option. Enables or disables user PIN at the start of cycle	OFF
9	Autom. Door unlock	0=OFF	1=ON	Enables or disables automatic door unlock at the end of the cycle	OFF
10	Font Display	0=EUR-JAP	1=EUR-CYR	Sets the font map to European / Japanese or European / Cyrillic	EUR-JAP
11	Display language	1	8	Selects the desired language for the display	ENGLISH
12	Resuming mode	0= PHASE RESTART 1= CYCLE RESTART	2= STANDBY	Resuming mode after an alarm or machine switch-off during the cycle. If at 0, the program restarts from the last phase in which the unscheduled stop occurred. If at 1 the program restarts each time from the beginning. If at 2 the program does not restart but remains in standby	STANDBY
13	Program button 1	1	40	Selects the program to be combined with button 1	1



ID	Parameter Name	Min	Max	Description	Factory Default
14	Program button 2	1	40	Selects the program to be combined with button 2	2
15	Program button 3	1	40	Selects the program to be combined with button 3	3
16	Printer language	1	8	Selects the desired language for the printer	ENGLISH
17	Drying enable	0=OFF	1=ON	Enables or disables the drying stage (not available on models without drying system)	ON
18	Lower Spray Arm	0=OFF	1=ON	Enables or disables lower spray arms	OFF
19	White LED always ON	0=OFF	1=ON	Enables or disables the washing chamber's LED light	OFF
20	Fahrenheit temperature	0=OFF	1=ON	Sets the temperatures display in °F degrees	OFF
21	PIN expiration month	1	99	Set password expiration time	6
22	User PIN enable at the end of cycle	0=OFF	1=ON	Available only with "User PIN Management" option. Enables or disables user PIN at the end of cycle	OFF
23	Upper Spray Arm	0=OFF	1=ON	Enables or disables upper spray arms	OFF
<b>TEMPERATURES</b>					
1	Fan activation	0°C 32°F	100°C 212°F	Cooling fan operating temperature, when the machine reaches and exceeds the set temperature, the cooling fan turns on	50°C 122°F
<b>TIMES</b>					
1	Time LED lights	0	999	Washing chamber light switch-on time	5 minutes
2	Fan time	0	99	Fan operating time at the end of the cycle when the temperature is higher than the one set	5 minutes
<b>PUMPS</b>					
1	Cold water flowmeter	0=OFF	1=ON	Enables or disables the cold water flowmeter	ON
2	Cold filling time	0	1000	Sets the timer for the pump in the absence of the flowmeter count	52 seconds
3	Hot water flowmeter	0=OFF	1=ON	Enables or disables the hot water flowmeter	OFF

ID	Parameter Name	Min	Max	Description	Factory Default
4	Hot water filling time	0	1000	Sets the timer for the pump in the absence of the flowmeter count	52 seconds
5	Deionized water flowmeter	0=OFF	1=ON	Enables or disables the deionized water flowmeter	ON
6	Deionized water filling time	0	1000	Sets the timer for the pump in the absence of the flowmeter count	52 seconds
7	Product 1 enable	0=OFF	1=ON	Enables or disables the product 1 pump	ON
8	Product 1 flowmeter	0=OFF	1=ON	Enables or disables the product 1 flowmeter	ON
9	Product 2 enable	0=OFF	1=ON	Enables or disables the product 2 pump	OFF
10	Product 2 flowmeter	0=OFF	1=ON	Enables or disables the product 2 flowmeter	ON
11	Product 3 enable	0=OFF	1=ON	Enables or disables the product 3 pump	ON
12	Product 3 flowmeter	0=OFF	1=ON	Enables or disables the product 3 flowmeter	ON
13	Product 4 enable	0=OFF	1=ON	Enables or disables the product 4 pump	OFF
14	Product 4 flowmeter	0=OFF	1=ON	Enables or disables the product 4 flowmeter	ON

#### REGENERATION

1	Water hardness (°fH)	0	60	French degrees of water. 1°fH = 10 PPM CaCO <sub>3</sub>	25°fH
---	----------------------	---	----	---	-------

#### CONDUCTIVITY PROBE

1	Probe activation	0=OFF	1=ON	Enables or disables the conductivity probe	OFF
---	------------------	-------	------	--	-----

#### CLOCK

1	Date and Time	DW DD/MM/YY HH:MM:SS		Sets current date and time
---	---------------	-------------------------	--	----------------------------

#### CYCLES COUNTER

1	Total Cycles	Number of machine life cycles		
2	Program cycles 1	Number of cycles performed with program 1		
3	Program cycles 2	Number of cycles performed with program 2		
4	Program cycles 3	Number of cycles performed with program 3		

ID	Parameter Name	Min	Max	Description	Factory Default
5	...			Number of cycles performed with program...	
6	Program cycles 40			Number of cycles performed with program 40	
<b>USER PIN</b>					
1	Pin User 1			To set the user password, press the RESET key and enter the 6 desired numbers	
2	Pin User 2				
3	...				
4	Pin User 20				
5	PIN SuperUser				
<b>PRINT LAST CYCLE</b>					
1	Print Last Cycle			With printer enabled the last cycle performed can be printed	

## 12.2 MENU STRUCTURE

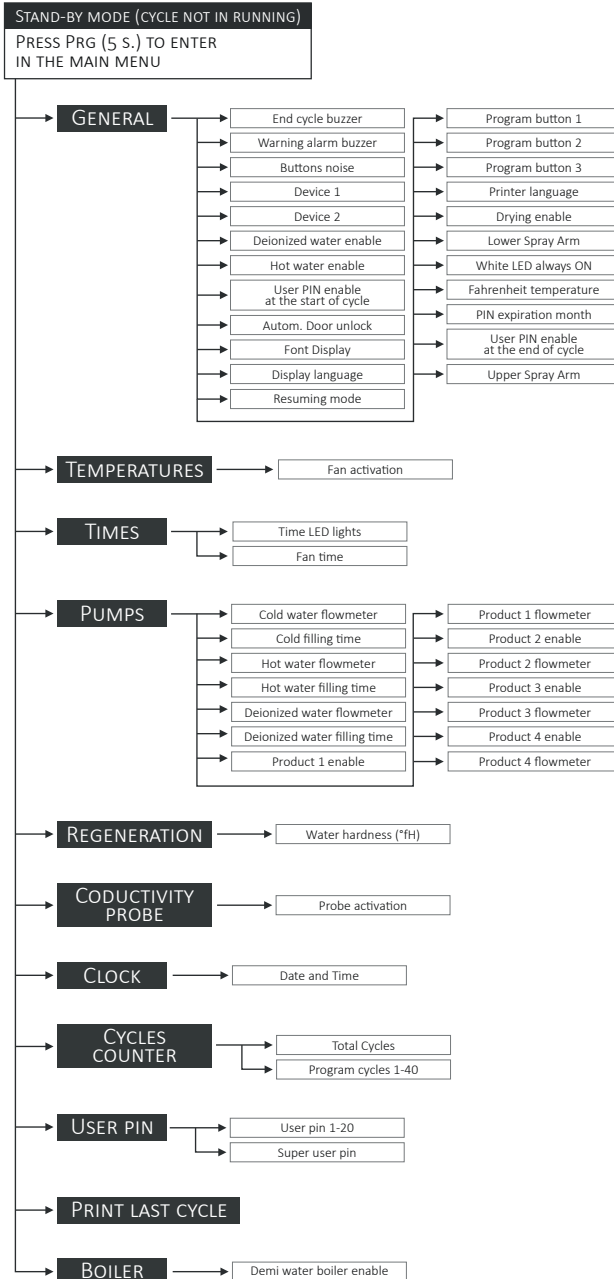

**12.3 PROCEDURE FOR PASSWORD CHANGE**

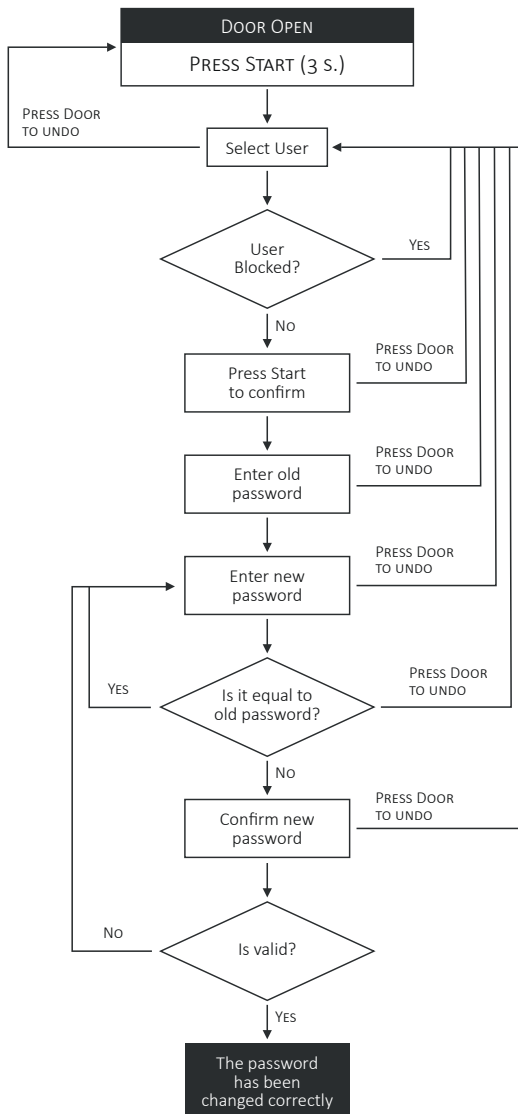

**12.4 PROCEDURE FOR USER PASSWORD SETUP FOR THE SUPER USER**

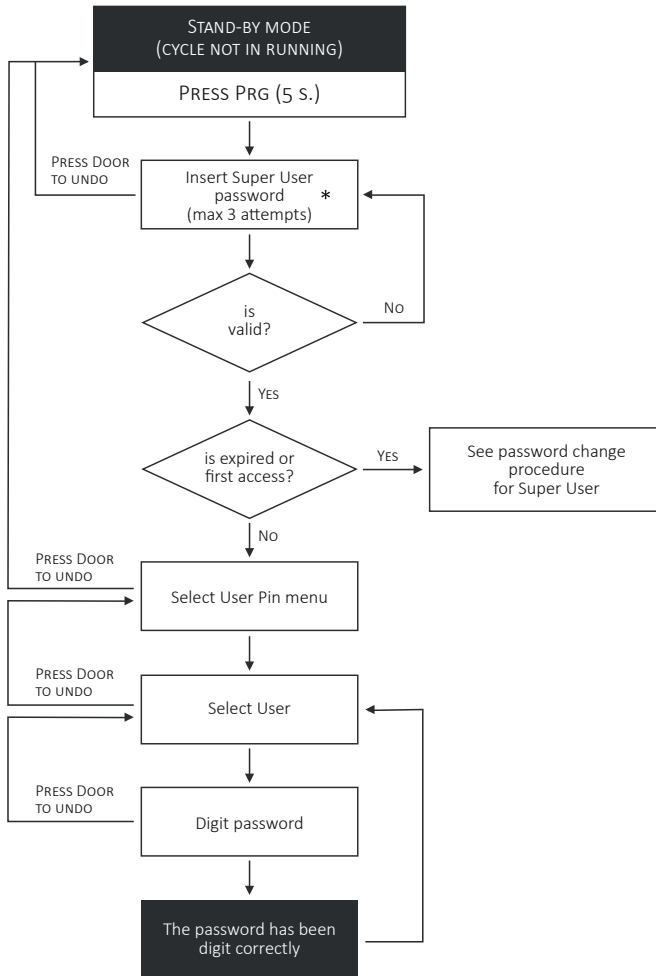

\*At the first access enter: 111111

### 12.5 PROCEDURE FOR SUPER USER PASSWORD CHANGE

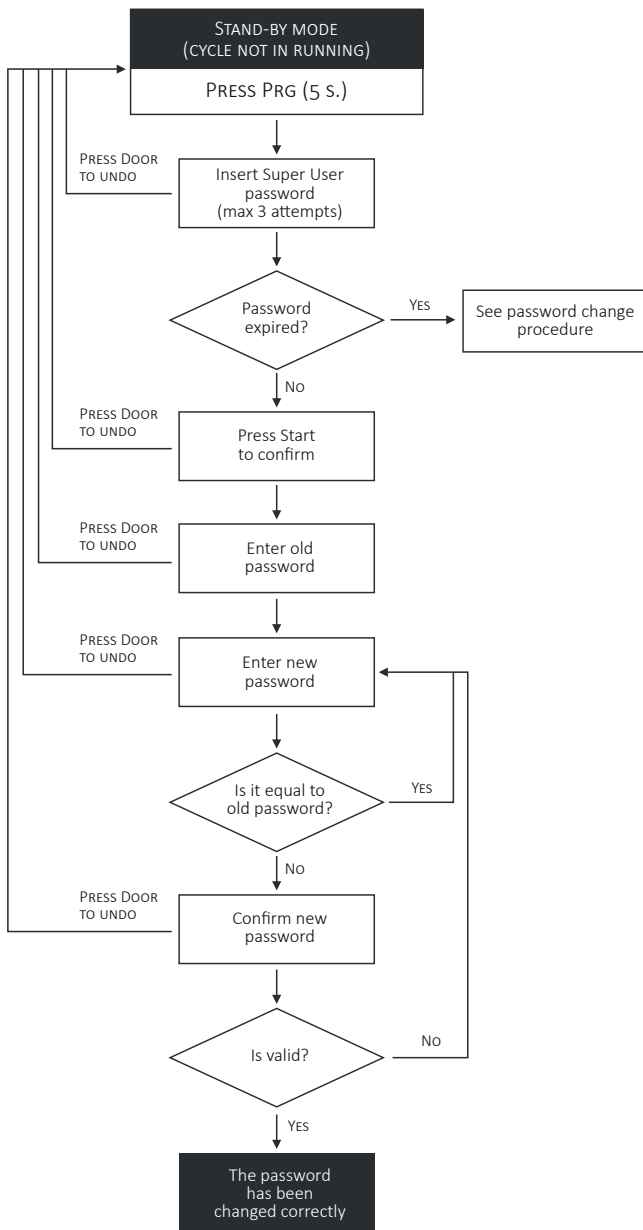

## 12.6 ALARM TABLE

ALARM	DESCRIPTION	ACTION	
E00	EEPROM ALARM	Firmware installed successfully.	1- Press RESET 2- Install new dataset
E01	BLACKOUT	A blackout occurred during cycle execution and the program was stopped.	Press RESET
E02	DOOR OPEN	The door is open or unlocked. Close the door.	Press RESET If it persists, call the service personnel.
E07	NO LOCKED DOOR	The door did not lock within the set time.	Press RESET If it persists, call the service personnel.
E09	NO UNLOCKED DOOR	The door did not unlock within the set time.	Press RESET If it persists, call the service personnel.
E11	DIRTY WATER	Check for dirt on the load and check the inlet demineralized water.	Press RESET If it persists, call the service personnel.
E20	NO COLD WATER	The cold water tap could be closed or partially open. Check it.	Check if the safety floatswitch has not tripped. Press RESET If it persists, call the service personnel.
E21	NO HOT WATER	The hot water tap could be closed or partially open. Check it.	Press RESET If it persists, call the service personnel.
E22	NO DEMI WATER	The demineralized water tap could be closed or partially open. Check it.	Press RESET If it persists, call the service personnel.
E26	PRINTER ERROR	The printer is turned off, unplugged or out of paper. Check it.	Press RESET If it persists, call the service personnel.
E30	FLOWMETER 1	Chemical liquid tank 1 might be empty. Check it.	Press RESET If it persists, call the service personnel.
E31	FLOWMETER 2	Chemical liquid tank 2 might be empty. Check it.	Press RESET If it persists, call the service personnel.
E32	FLOWMETER 3	Chemical liquid tank 3 might be empty. Check it.	Press RESET If it persists, call the service personnel.
E33	FLOWMETER 4	Chemical liquid tank 4 might be empty. Check it.	Press RESET If it persists, call the service personnel.
E34	PRODUCT TIMEOUT	The density of the chemical liquid might be too high. Check it.	Press RESET If it persists, call the service personnel.
E41	DRAIN TIMEOUT	The drain pipe might be blocked or clogged. Check it.	Press RESET If it persists, call the service personnel.



ALARM		DESCRIPTION	ACTION
E43	DRY TEMPERATURE	The load might not be dried because the minimum set temperature has not been reached.	Press RESET If it persists, call the service personnel.
E44	PREWASH TEMPERAT	A too high temperature was detected during the prewash phase.	Press RESET If it persists, call the service personnel.
E45	CHAMBER T.LIMIT	A too high temperature was detected inside the chamber.	Press RESET If it persists, call the service personnel.
E46	AIR T.LIMIT	A too high air temperature was detected.	Press RESET If it persists, call the service personnel.
E47	PHASE T. LIMIT	A too high temperature was detected during the current phase.	Press RESET If it persists, call the service personnel.
E50	PROBE 1 BROKEN	Chamber probe PT1000-1 (work) might be broken or disconnected.	Press RESET If it persists, call the service personnel.
E51	PROBE 2 BROKEN	Chamber probe PT1000-2 (control) might be broken or disconnected.	Press RESET If it persists, call the service personnel.
E52	AIR PROBE BROKEN	Air probe PT1000-3 might be broken or disconnected.	Press RESET If it persists, call the service personnel.
E53	CHAMBER T. DIFF	A temperature difference between the probes in the chamber has been detected too high.	Press RESET If it persists, call the service personnel.
E62	BUS CABLE	A connection anomaly has been detected on the bus between the Micro-1 and Micro-2 boards.	Press RESET If it persists, call the service personnel.
E66	NO HEATING	There is a problem with water heating.	Press RESET If it persists, call the service personnel.
E67	CONDENSER LEVEL	The water inside the steam condenser has reached the maximum level allowed.	Press RESET If it persists, call the service personnel.
E70	PUMP PRESSURE	There could be water leaks.	Press RESET If it persists, call the service personnel.
E71	HEPA FILTER	The HEPA filter might be dirty or clogged. Check it.	Press RESET If it persists, call the service personnel.
E75	PRODUCT 1 EMPTY	Chemical liquid tank 1 is empty. Add liquid.	Press RESET If it persists, call the service personnel.
E76	PRODUCT 2 EMPTY	Chemical liquid tank 2 is empty. Add liquid.	Press RESET If it persists, call the service personnel.
E77	PRODUCT 3 EMPTY	Chemical liquid tank 3 is empty. Add liquid.	Press RESET If it persists, call the service personnel.

ALARM	DESCRIPTION	ACTION
E78 PRODUCT 4 EMPTY	Chemical liquid tank 4 is empty. Add liquid.	Press RESET If it persists, call the service personnel.
E80 SPRAY ARM LOCKED	The spray arm marked in red on display is locked. Remove it and clean.	Press RESET If it persists, call the service personnel.
E89 NO DISINFECTION	The minimum value of A0 was not reached and the load is still contaminated.	Press RESET If it persists, call the service personnel.

## 12.7 WARNINGS TABLE

WARNING TYPE	DESCRIPTION	ACTION
LIQUID RESERVE PRODUCT 1	Product 1 is in reserve or may be empty.	Add the product 1
LIQUID RESERVE PRODUCT 2	Product 2 is in reserve or may be empty.	Add the product 2
LIQUID RESERVE PRODUCT 3	Product 3 is in reserve or may be empty.	Add the product 3
LIQUID RESERVE PRODUCT 4	Product 4 is in reserve or may be empty.	Add the product 4
REQUEST MAINTENANCE	Contact customer service or the dedicated technical assistance for periodic maintenance.	Press RESET
REQUEST VALIDATION	Contact customer service or the dedicated technical assistance for periodic validation.	Press RESET
REFILL SALT TANK	1- Take out the basket 2- Unscrew the cap of the salt tank 3- Fill the salt tank 4- Screw the cap of the salt tank	Press RESET For 5 seconds

## 12.8 TROUBLESHOOTING

PROBLEM	CAUSE	SOLUTION
1 The machine does not start	The fuse / circuit breaker of the electrical system has tripped.	Enable the fuse / switch of the electrical system.
2 The program does not start	Door not closed correctly.	Check door closure.
3 The program stops	No chemical products.	Turn off the machine and fill the containers.
	Water flow closed.	Open the water flow.
4 The operating temperature for the program is not reached	The thermostat sensor in the washing chamber is covered with deposits.	Clean the thermostat sensor.
5 The machine does not dry	The air filter in the drying system is dirty or clogged.	Replace the filter. Have special maintenance performed by technical assistance.
6 White deposits in the washing chamber	Softener finished due to lack of salt.	Add the salt for regeneration.

## 12.9 FUSES

	FUSES OF THE MACHINE							
	2FU1	2FU2	2FU3	2FU4	2FU5	2FU6	2FU7	2FU8
<b>208-240V 3~ 60 HZ</b>	5x20 T6.3A	5x20 T1.25A	5x20 T4A	5x20 T2A	5x20 T3.15A	6.3x32 T20A	6.3x32 T20A	6.3x32 T20A
<b>208-240V 2~ 60 HZ</b>	5x20 T6.3A	5x20 T1.25A	5x20 T4A	5x20 T2A	5x20 T3.15A	6.3x32 T20A	6.3x32 T20A	-

**12.10 RS232 LAN CONNECTION**

Byte	Type	Description	Unit	Managed by the machine	Example	
					Byte	Value
0		"@" = Start character				
1 2 3 4	<b>PRG</b>	Program selected	n	Yes	0 0 1 2	12
5 6 7 8	<b>PHA</b>	Type phase in execution	n	Yes	0 0 0 8	8
9 10 11 12	<b>TPT1</b>	PT1000-1 temperature (chamber work probe)	°C	Yes	0 7 6 6	76.6
13 14 15 16	<b>TPT2</b>	PT1000-2 temperature (chamber control probe)	°C	Yes	0 3 1 0	31.0
17 18 19 20	<b>TPT3</b>	PT1000-3 temperature (air probe)	°C	Yes	0 1 0 4	104
21 22 23 24	<b>ERR</b>	Alarm number	n	Yes	0 0 7 0	70
25 26 27 28 29 30	<b>CYC</b>	Counter programs executed	n	Yes	0 0 0 1 6 8	168
31 32 33 34	<b>REMT</b>	Time remaining at the end of a program	min	Yes	0 0 9 0	90
35 36 37 38	<b>PRP</b>	Wash pump pressure status	n	Yes	0 0 0 2	2
39 40 41 42	<b>VDP1</b>	Doser quantity 1	ml	Yes	0 0 3 6	36
43 44 45 46	<b>VDP2</b>	Doser quantity 2	ml	Yes	0 0 0 8	8
47 48 49 50	<b>VDP3</b>	Doser quantity 3	ml	Yes	0 0 0 3	3

Byte	Type	Description	Unit	Managed by the machine	Example	
					Byte	Value
51 52 53 54	<b>VDP4</b>	Doser quantity 4	ml	Yes	0 0 0 0	0
55 56 57 58	<b>VDP5</b>	Doser quantity 5	ml	No	0 0 0 0	0
59 60 61 62	<b>VCW</b>	Cold water quantity	liters	Yes	0 0 0 6	6
63 64 65 66	<b>VHW</b>	Hot water quantity	liters	Yes	0 0 0 0	0
67 68 69 70	<b>VDW</b>	Deionized water quantity	liters	Yes	0 0 0 6	6
71 72 73 74	<b>CONP</b>	Conductivity probe status	n	Yes	0 0 0 2	2
75 76 77 78 79	<b>A0</b>	A <sub>0</sub> Value	n	Yes	0 6 1 8 0	6180
80 81 82 83	<b>SPRYR.B</b>	Spray arm at the bottom of the chamber rotation monitoring	rpm	Yes	0 0 8 8	88
84 85 86 87	<b>SPRYR.1</b>	Spray arm 1 rotation monitoring	rpm	No	0 0 0 0	0
88 89 90 91	<b>SPRYR.2</b>	Spray arm 2 rotation monitoring	rpm	No	0 0 0 0	0
92 93 94 95	<b>SPRYR.3</b>	Spray arm 3 rotation monitoring	rpm	No	0 0 0 0	0
96 97 98 99	<b>SPRYR.4</b>	Spray arm 4 rotation monitoring	rpm	No	0 0 0 0	0
100 101 102 103	<b>SPRYR.5</b>	Spray arm 5 rotation monitoring	rpm	No	0 0 0 0	0

Byte	Type	Description	Unit	Managed by the machine	Example	
					Byte	Value
104 105 106 107	<b>SPRYR.A</b>	Spray arm at the top of the chamber rotation monitoring	rpm	Yes	0	0
0						
0						
0						
108 109 110	<b>CHPRS</b>	Chamber pressure	bar	No	0	0.50
5						
0						
111 112 113	<b>TRPRS</b>	Trolley pressure	bar	No	1	1.00
0						
0						
114 115		Checksum		Yes		
116		"0x2A" = "*" = Stop character		Yes		
117		"0x0D" = "CR" = Carriage return		Yes		

**PRG: PROGRAM SELECTED**

<b>0000</b>	No program selected	.....	.....
<b>0001</b>	Program 1	<b>0040</b>	Program 40

**PHA: TYPE PHASE IN EXECUTION**

<b>0001</b>	Drain	<b>0010</b>	Trolley insertion
<b>0002</b>	Prewash	<b>0011</b>	Door closure
<b>0003</b>	Wash	<b>0012</b>	Program selection
<b>0004</b>	Rinse	<b>0013</b>	Operator scan
<b>0005</b>	Disinfection	<b>0014</b>	Trolley scan
<b>0006</b>	Drying	<b>0015</b>	End of the program
<b>0007</b>	Regeneration	<b>0016</b>	Alarm
<b>0008</b>	Standby	<b>0017</b>	Program interrupted
<b>0009</b>	Maintenance / Validation		

**TPT1 - TPT2**

<b>0000</b>	0.0°C	.....	.....
<b>0001</b>	0.1°C	<b>900</b>	90.0°C
<b>0002</b>	0.2°C		

**TPT3**

<b>0000</b>	0°C	.....	.....
<b>0001</b>	1°C	<b>0110</b>	110°C
<b>0002</b>	2°C		

**ERR: ALARM**

<b>0000</b>	No alarm	.....	.....
<b>0001</b>	Alarm 1	<b>0099</b>	Alarm 99

**CYC: COUNTER PROGRAMS EXECUTED**

<b>000000</b>	0 programs executed	.....	..... programs executed
<b>000001</b>	1 program executed	<b>999999</b>	999999 programs executed
<b>000002</b>	2 programs executed		

**REMT: PROGRAM REMAINING TIME**

<b>0000</b>	0 minutes until program end	.....	..... minutes until program end
<b>0001</b>	1 minute until program end	<b>0120</b>	120 minutes until program end
<b>0002</b>	2 minutes until program end		

**PRP: WASHING PUMP PRESSURE**

<b>0000</b>	Pressure not measured	<b>0002</b>	Pressure is correct
<b>0001</b>	Pressure is not correct		

**VDP1 / VDP2 / VDP3 / VDP4 / VDP5: QUANTITY OF PRODUCT DELIVERED**

<b>0000</b>	0 ml of product delivered	.....	..... ml of product delivered
<b>0001</b>	1 ml of product delivered	<b>0150</b>	150 ml of product delivered

**VCW / VHW / VDW: QUANTITY OF WATER DELIVERED**

<b>0000</b>	0 liters of water delivered	.....	..... liters of water delivered
<b>0001</b>	1 liter of water delivered	<b>0012</b>	12 liters of water delivered

**CONP: CONDUCTIVITY PROBE**

<b>0000</b>	Conductivity probe not active	<b>0002</b>	Conductivity value not OK (dirty water)
<b>0001</b>	Conductivity value OK (clean water)		

**A<sub>0</sub> VALUE**

<b>00000</b>	A <sub>0</sub> Value = 0	.....	A <sub>0</sub> Value = .....
<b>00001</b>	A <sub>0</sub> Value = 1	<b>09999</b>	A <sub>0</sub> Value = 9999

**SPRYR.B / SPRYR.1 / SPRYR.2 / SPRYR.3 / SPRYR.4 / SPRYR.5 / SPRYR.A:  
SPRAY ARM ROTATION MONITORING**

<b>0000</b>	0 rpm	.....	..... rpm
<b>0001</b>	1 rpm	<b>0070</b>	70 rpm

**CHPRS: CHAMBER PUMP PRESSURE**

<b>000</b>	0 bar	.....	.....
<b>050</b>	0.50 bar	<b>100</b>	1.00 bar

**TRPRS: TROLLEY PUMP PRESSURE**

<b>000</b>	0 bar	.....	.....
<b>050</b>	0.50 bar	<b>100</b>	1.00 bar













**TUTTNAUER USA Co.LTD.**  
**25 POWER DRIVE HAUPPAUGE, N.Y. 11788, USA**  
**TEL. +1 631 737 48 50 / +1 800 624 58 36**  
**FAX +1 631 737 07 20**  
**WEB: [WWW.TUTTNAUERUSA.COM](http://WWW.TUTTNAUERUSA.COM)**