

Instructions for Use



RIS-311 - ENG - Rev03

lexa^{PLUS}
RIS-311

Table of contents



Conformity	5	Hide/Unhide a cycle	40
Symbols and messages	6	Managing printers	41
Introduction	8	Printer selection (optional)	41
About this manual	8	Label printer selection (optional)	41
Use restrictions	9	Label printer usage (optional)	42
Safety information	12	Label content description	44
Safety warnings	12	Sterilizer tests	45
Responsibility	14	Sterilizer performance tests	45
Getting started	15	Bowie and Dick test	45
Unpacking	15	Vacuum test	47
Handling	18	Sterilization cycles	49
Product description	19	Load maintenance and preparation	49
Installing the sterilizer	23	Typical loads	51
Operating the sterilizer	27	Prepare the sterilizer	52
User interface menu	28	Sterilization cycle description	53
Sterilizer setup	34	Sterilization cycle management	54
User authentication (optional)	35	Unloading	59
EliTrace (optional)	36	Sterilization cycle report	59
USB pen drive	36	Maintenance	64
Standby mode	37	Warnings for maintenance operations	64
Administrator	38	User maintenance	64
User management (optional)	38	Monthly or 50-cycle maintenance	66
Traceability options (optional)	39	400-cycle maintenance	69

800-cycle or biannual maintenance	70
1200-cycle or yearly maintenance	73
Extraordinary maintenance	75
Disposal	76
Diagnostics	77
Errors	77
Troubleshooting	82
Emergency door opening	87
Technical data	90
Sterilization programs	90
Sterilization cycle phases	93
Technical data	97
Recommendations for validation	98
Diagrams	99
Water quality	100
Accessories, spare parts, consumables	102
Authorized W&H service partners	104
Documentation forms	105
W&H installation check-list	105

Conformity

CONFORMITY TO EUROPEAN AND AMERICAN REGULATIONS, STANDARDS AND DIRECTIVES

Sterilizer conforms with the following Regulations, Standards and Directives:

Standards and Directives	Description
 0051	Medical Device Regulation (MDR). Regulation (UE) n. 2017/745 for medical devices. Class IIb devices, in accordance with the Rule 16 – ANNEX VIII of the above Regulation.
	For Device in compliance with Machinery Directive (2006/42/EC), Low Voltage Directive (2014/35/EU) and Electromagnetic Compatibility Directive (2014/30/EU).
 0497 2014/68/EU	Pressure Equipment Directive (PED). Directive 2014/68/EU (PED – Pressure Equipment Directive) for every sterilization chamber designed and manufactured in conformity to the ANNEX 1 and to the procedure described in the module D1 Annex III.
2012/19/EU	Waste Electrical and Electronic Equipment Directive (WEEE).
CSA C22.2 No. 61010-1	Safety requirements for electrical equipment for measurement, control and laboratory use, general requirements.
UL 61010-1	Safety requirements for electrical equipment for measurement, control and laboratory use, general requirements.

Standards and Directives	Description
ASME	Boiler and pressure vessel code.
EN 13060	Small steam sterilizers.
ANSI/AAMI ST55	Table-top steam sterilizers.
IEC 61010-1	Safety requirements for electrical equipment for measurement, control and laboratory use, general requirements.
IEC 61010-2-040	Safety requirements for electrical equipment for measurement, control and laboratory use; particular requirements for sterilizers and washer-disinfectors used to treat medical materials.
IEC 61326-1	Electrical equipment for measurement, control and laboratory use - EMC requirements; general requirements.
IEC 61770	Electric appliances connected to the water mains - Avoidance of backsiphonage and failure of hose-sets.

Note: Every new sterilizer is delivered with a Declaration of Conformity and a Warranty Card.

Symbols and messages

SAFETY SYMBOLS USED IN THIS MANUAL



WARNING: Indicates a hazardous situation that, if not avoided, could result in death or serious injury.

Related to a sterilizer, these warnings indicate hazardous situations that could result in non-sterile conditions (e.g. non-sterile instruments) which could lead to fatal personal injury.



CAUTION: Indicates a hazardous situation that, if not avoided, could result in minor or moderate injury.

SYMBOLS DISPLAYED ON THE PRODUCT



Hot surfaces!
Risk of burns.



Hot steam!
Risk of burns.



Consult the
Instructions for Use
for important
cautionary
information.



Don't use drinking
water to fill the clean
water tank; use
distilled or
demineralized water
only.





Consult the
Instructions for Use.











Disposal / Do not
dispose of with normal
waste

PROPERTY DAMAGE MESSAGES

Notice: Indicates information considered important, but not hazard-related. Typically to avoid damage to the product.

STORAGE	Storage.
TRANSPORTATION	Transportation.
MD	Medical Device. Only for MDR devices.
SN	Serial Number.
REF	Catalogue number.
Max. P	Max. pressure / Max. allowable working pressure (MAWP).
	Temperature between XX °C and XX °C.
	Manufacturing date (YYYY-MM-DD).
	Country of manufacture.

	Manufacturer.
UDI	Unique Identification. Device
HIBC	Health industry bar code in accordance with HIBC Standard.
SMALL STEAM STERILIZER	Small Steam Sterilizer.
	This side up.
	Fragile, handle with care.
	Keep dry.
	The sterilizer must be transported by two authorized technicians due to its heavy weight.
	ON (supply) IEC 60417-5007.

	OFF (supply) IEC 60417-5008.
	IN-position of bistable push control IEC 60417-5268.
	OUT- position of bistable push control IEC 60417-5269.
	USB connection.
GS1 Logistic	GS1 datamatrix for logistic purpose.
#	Sterilizer type.
TC	Test connection.

Introduction

CONTENTS

This section deals with the following subjects:

About this manual	8
Use restrictions	9

About this manual

FOR YOUR SAFETY AND THE SAFETY OF YOUR PATIENTS

The purpose of this manual is to provide information about Lexa PLUS sterilizers to ensure:

- proper installation and set-up
- optimal use
- safe and reliable operation
- compliance with regular maintenance and servicing requirements

Please carefully read the safety information [see "Safety warnings" on page 12].

OBLIGATIONS WITH REGARD TO THIS MANUAL

This manual is an integral part of the product and accompanies it for its entire working life. It must be consulted in all situations related to the life cycle of the product, from its delivery through to decommissioning. For this reason, it should always be accessible to operators both online and offline.

Contact customer service in the event the manual is unavailable. If the device is transferred, always attach the manual for the new owner.

MANUAL CONTENT

This manual contains the Instructions for Use and for maintenance of the following sterilizer versions:

This manual contains the Instructions for Use and for maintenance of the following sterilizer version:

- RIS-311 200–240 V ac

DISCLAIMER

All pictures, graphics and illustrations provided in this manual are for the comprehension of the text. They are not meant to be an accurate representation of product details. Thus, they should be taken as indicative only, and may differ from the actual product.

For any suggestions or remarks please send an email to office.sterilization@wh.com.

COPYRIGHT NOTICE

Copyright ©, W&H Sterilization Srl

All rights reserved in all countries.

All drawings, images and texts contained in this manual are the property of the manufacturer. Even partial duplication of drawings, images or text is prohibited.

The information contained in this document is subject to change without prior notice.

Use restrictions

INTENDED USE

For Medical Device in accordance with Regulation EU 2017/745:

The small steam sterilizers are intended for the sterilization of invasive and non-invasive medical devices. The devices are intended for professional use by trained people only.

For other purposes out of the scope of Regulation EU 2017/745:

The small steam sterilizers are intended for the sterilization of devices other than invasive and non-invasive medical ones. The small steam sterilizers are intended for the sterilization in veterinary practices. They are also intended to be used for materials and equipment which are likely to come into contact with blood or body fluids, e.g. implements used by beauty therapists, tattooists, body piercers and hairdressers.

The devices are intended for professional use by trained people only.

For North American market:

Lexa PLUS is a dynamic-air-removal (pre-vacuum) table-top steam sterilizer intended for use by a healthcare provider to sterilize medical products by means of pressurized steam. It is suitable for the sterilization of medical and dental instruments that are validated

to be sterilized by steam.

The Lexa PLUS has not been designed to sterilize liquid loads, biomedical waste or materials not compatible with steam sterilization. The processing of such loads may result in incomplete sterilization and/or damage to the autoclave.

Key program features, including sterilization time, temperature and recommended load type are listed in the following table:

Program	Type of Load and Load weight	Sterilization Temperature	Sterilization Time	Drying Time (recommended)
Wrapped	Pouched Instruments and Dental Handpieces on trays 14 lbs (6.3 kg) (trays excluded). Instruments and dental handpieces in wrapped cassettes or in trays and wrapped cassettes 16.5 lbs (7.5 kg) (trays and cassettes included). Pouched Textile load on trays 4.4 lbs (2.0 kg) (trays excluded).	270 °F (132 °C)	4 minutes	22 minutes

Program	Type of Load and Load weight	Sterilization Temperature	Sterilization Time	Drying Time (recommended)
Low Temperature	Pouched Instruments (solid instruments) on trays 14 lbs (6.3 kg) (trays excluded). Solid instruments in wrapped cassettes or in trays and wrapped cassettes 16.5 lbs (7.5 kg) (trays and cassettes included). Pouched Textile load on trays 4.4 lbs (2.0 kg) (trays excluded).	250 °F (121 °C)	30 minutes	28 minutes
Unwrapped	Instruments and dental handpieces, up to 18 lbs (8.1 kg).	270 °F (132 °C)	4 minutes	4 minutes

See "Sterilization programs" on page 90 for the full list of key program features, including sterilization time, temperature, drying time and recommended load type.

USER QUALIFICATION

The users who may operate the sterilizer are the following.

User qualification	Competences
Head of the clinic/practice	Legally responsible for: <ul style="list-style-type: none"> ■ the efficiency of the hygiene protocol in place ■ the sterilization process ■ the operators' training and training documentation ■ the correct operation and maintenance of the equipment
Trained operators	<ul style="list-style-type: none"> ■ Regularly attend the training for operating and using the sterilizer safely. ■ Use the sterilizer according to the Head of the clinic/practice's instructions.

Safety information

CONTENTS

This section deals with the following subjects:

Safety warnings	12
Responsibility	14

Safety warnings

THERMAL HAZARDS



- The chamber automatically begins to heat to high temperature as soon as the sterilizer is switched on – risk of burns!
- The trays and the sterilization load are hot at the end of each cycle. Use tray or cassette holders to empty the sterilization chamber.
- Always wear appropriate PPE during use of the sterilizer (e.g. gloves for cleaning, maintenance, etc...).

ELECTRICAL RISKS



- Do not pour water or any other liquids over the sterilizer (risk of electrical short circuits).
- Switch off the sterilizer and unplug the mains cable before inspecting, carrying out maintenance or servicing the sterilizer.
- Ensure that the power receptacle the sterilizer is connected to is properly grounded.
- All electric devices connected to the sterilizer shall be of Insulation Class II (double insulated) or higher.
- Use only the power cord provided by the manufacturer.

IMPROPER USE OF THE STERILIZER



- The sterilizer must not be used in presence of explosive or flammable gases, vapors, liquids or solids.
- The sterilizer has not been designed for the sterilization of foodstuff or waste.
- Do not exceed the maximum load weight limits as specified in this manual (see "Run a sterilization cycle" on page 54).
- Do not drink any water that has been inside the sterilizer.

TAMPERING



- Do not remove the name plate or labels from the sterilizer.
- Repairs, maintenance or service must be carried out by authorized service providers always using genuine spare parts.

REQUIREMENTS



- All accessories connected to the sterilizer shall be FDA cleared.
- Use only the power cord set and accessories provided by the manufacturer.
- Serious incidents that have occurred in relation to this medical device should be reported to the manufacturer and competent authority in the country where the incident occurred.
- In case of malfunction of the sterilizer, contact an authorized technician or the manufacturer.

CYBER SECURITY

The device is designed in such a way that a cyber-attack or software failure does not compromise the safety in relation to the intended use. A successful cyber-attack cannot result in direct patient harm: in fact, the device is not in contact with patients.

The device does not share any data (sensible and not sensible) related to patients.

To further protect the device and minimize successful cyber-attacks, the following precautions have been taken:

- the access to the device operating system is not possible (user access to the operating system is disabled);
- a firewall is active on the device; all the device network connections (to and from the external world) are managed by the firewall which, following specific rules, filters them and blocks everything that is not strictly necessary for the device;
- the update/install operations are only possible using signed and crypted software, provided by W&H;
- during the normal use, the operating system and the application (responsible for the device functionalities) are located in a read-only memory, so to avoid intentional corruption;
- all the sterilization data are secured by means of checksum controls.

In order to minimize the possibility of cyber-attacks, it is user responsibility to apply the following measures:

- software update/install shall be done by authorized and trained personnel only;
- it is recommended to activate a firewall on the router/modem used for the internet connection.

Note: further security information is mentioned in the MDS2 document, which is available on request.

Responsibility

USER RESPONSIBILITY

- The user is responsible for the proper installation, the correct use and maintenance of the sterilizer in accordance with these Instructions for Use.
- The safety devices of the sterilizer are impaired when the product itself is not installed, used and serviced in accordance with these Instructions for Use.
- The Instructions for Use updated to the latest version is always available at www.wh.com.
- Keep these Instructions for Use for future reference.

MANUFACTURER RESPONSIBILITY

- The manufacturer can only accept responsibility for the safety, reliability and performance of the product when the product itself is installed, used and serviced in accordance with the Instructions for Use.
- Servicing by unauthorized persons invalidates all claims under warranty and any other claims.

Getting started

CONTENTS

This section deals with the following subjects:

Unpacking	15
Handling	18
Product description	19
Installing the sterilizer	23
Operating the sterilizer	27
User interface menu	28
Sterilizer setup	34
User authentication (optional)	35
EliTrace (optional)	36
USB pen drive	36
Standby mode	37

Unpacking

UNPACK THE STERILIZER



CAUTION! Heavy product. The sterilizer must be removed from the box and transported by two authorized technicians.

Weight: 133.4 lbs (60.5 kg)

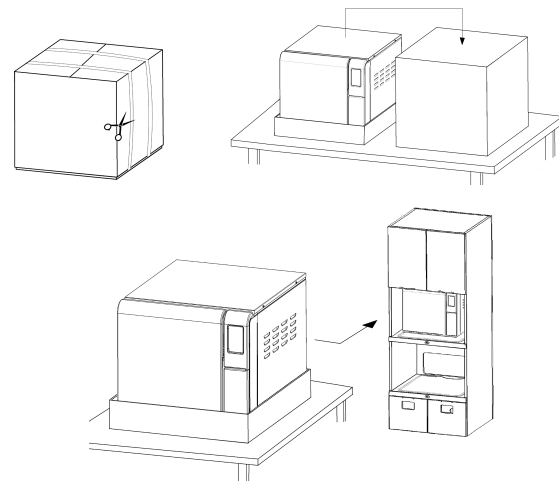

WARNINGS

Notice: check the external conditions of the box and the sterilizer. In case of any damage, immediately contact the dealer or shipping agent that has carried out the transport. Keep the packaging for shipping or transporting the sterilizer in the future.

Note: The packaging of the product is environmentally friendly and can be disposed of by industrial recycling companies.

CONTENTS OF THE PACKAGING

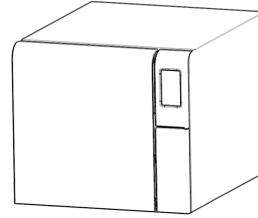

Sterilizer

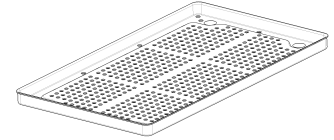

Trays (three + two)

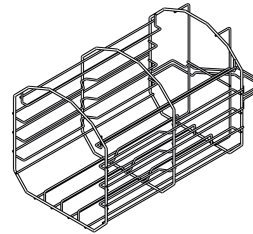

Chamber rack

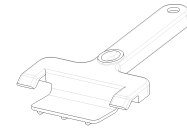

Tray holder

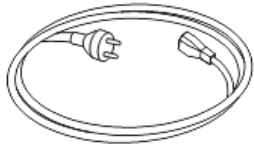

Power cord



Drain tube

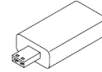

USB pen drive loaded with
Instructions for Use

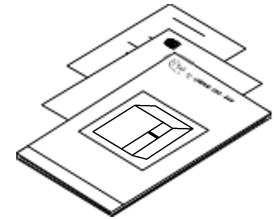

This manual, declaration of
conformity, warranty card, work
test report

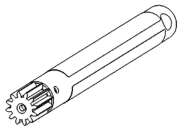

Emergency door opening tool



Tube for drain connection

ITEMS NOT PROVIDED WITH THE STERILIZER

The following items are not provided:

- Water container to capture waste water during manual tank draining (volume larger than 1.45 gal [5.5 l])
- LAN cable for connecting the sterilizer to a network (optional)

See "Accessories, spare parts, consumables" for a full list of optional accessories.

Handling

HOW TO RELOCATE THE STERILIZER

Before transport:

- Completely drain both water tanks (see "Draining the used and clean water tank" on page 75)
- Allow the sterilization chamber to cool down
- Use original packaging when shipping or transporting the sterilizer. Replacement packaging materials are available from Service W&H

Product description

FRONT VIEW

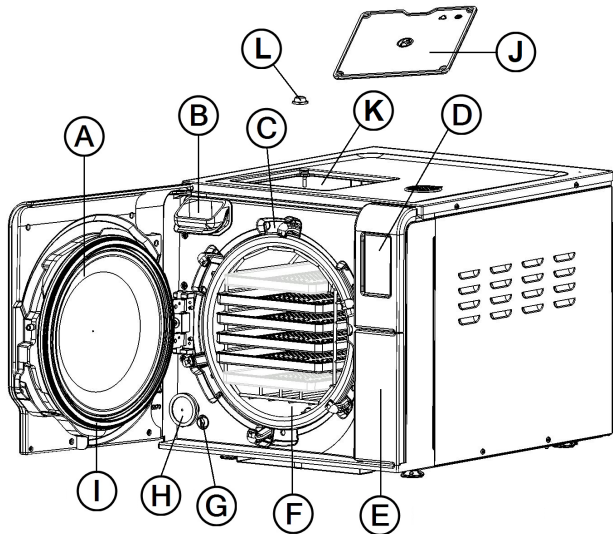

Part	Description
A	Chamber door
B	Clean water tank filling point
C	Door locking system
D	Touch screen
E	Service door
F	Sterilization chamber
G	Safety thermostat reset
H	HEPA filter
I	Door gasket
J	Clean tank cover-cap
K	Clean water tank
L	Tank internal filter with metal cartridges

COMPONENTS BEHIND THE SERVICE DOOR

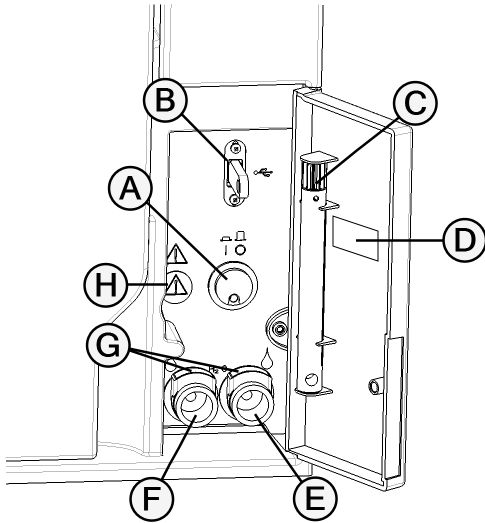

Part	Description
A	Mains switch
B	USB port
C	Emergency door opening tool
D	Identification label
E	Used water drain connection (grey)
F	Clean water drain connection (blue)
G	Drain tube release buttons
H	Port for emergency door opening tool

REAR VIEW

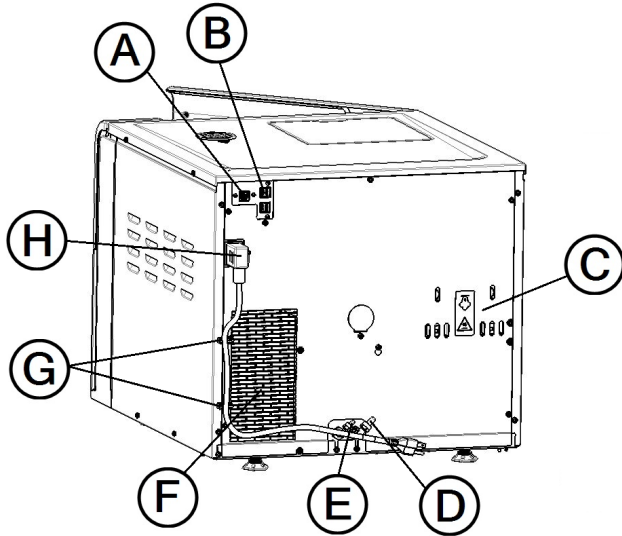

Part	Description
A	LAN port
B	USB ports
C	Pressure safety valve cover
D	Used water drain
E	Water supply inlet
F	Condenser grid
G	Power cord guides
H	Power cord socket

CHAMBER ACCESSORIES

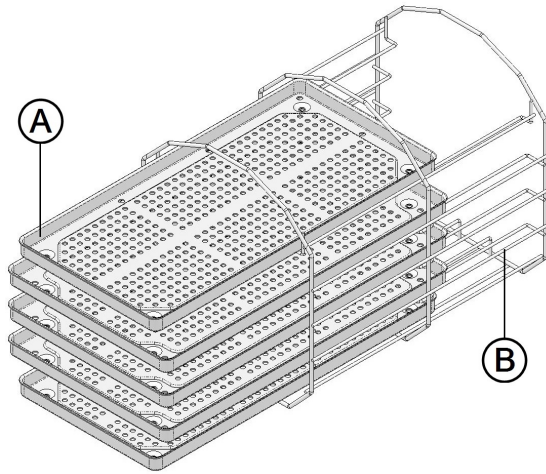

Part	Description
A	Tray
B	Chamber rack. It can host trays or cassettes inserted horizontally or vertically.

Installing the sterilizer

LOCATION REQUIREMENTS

Notice:

Do not place the sterilizer so that it is difficult to operate the controls behind the service door. Do not place the sterilizer so that it is difficult to disconnect the power cord.

Leave the condenser grid (rear side of the sterilizer) free from anything that might obstruct the air passage.

Surface materials should be water resistant. If sterilization cycles will be continuous, pay attention to the surrounding materials: steam can damage them.

The sterilizer must operate in absence of explosive atmospheres. The sterilizer must operate in a well ventilated room (indoor), far from sources of heat and from flammable materials.

Place the sterilizer on a flat and level surface.

Clearance requirements to ensure proper air circulation:

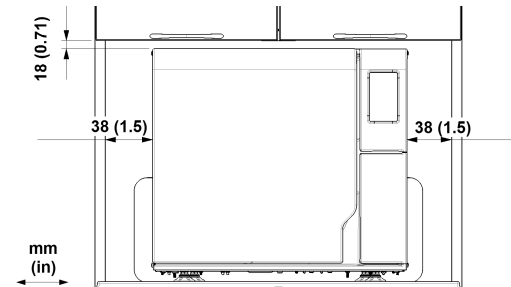

Make sure that the clean water tank can be easily accessed for periodic cleaning operations.

ELECTRICAL CONNECTIONS

All the cables and tubes connected on the rear side of the sterilizer must be placed far from the condenser grid (e.g. using the available guides).

Notice:

Connect the sterilizer to a dedicated line. Do not use cable extensions nor multiple sockets/adapters.

Ensure that external and internal surfaces are free from moisture or condensation before connecting to power.

The installation of the sterilizer shall be performed by two authorized technicians using PPE (Personal Protective Equipment) according to applicable standards.

The electrical power supply of the sterilizer must fulfill all applicable standards in the country of use, and must comply with the data label on the back of the sterilizer.

WATER CONNECTIONS

The sterilizer clean water tank can be filled manually by the user or automatically with a water supply system. The water supply system must deliver demineralized or distilled water meeting the specifications listed in these instructions. Do not add any chemical/additive to the water.

The manufacturer's warranty is void if the sterilizer was used with water containing either chemical additives, or contaminant levels exceeding those listed in these instructions. See "Water quality" on page 100 and "Feed water specifications (ANSI/AAMI and AAMI TIR34)" on page 100.

Notice: the maintenance of the external water filling system must be done in exact accordance with the Instructions for Use given with the relevant system.

WATER TANKS

At every cycle the sterilizer uses new fresh water and, at the end of the cycle, discharges it. Thus, the sterilizer is fitted with two water tanks : the clean water tank and the used water tank.

For this reason is necessary to periodically fill the clean water tank and draining the used water tank.

FILLING THE CLEAN WATER TANK

Notice:

Before carrying out the following steps, make sure that the sterilizer has completed the cycle in progress.

Always wear appropriate PPE during use of the sterilizer (e.g. gloves for cleaning, maintenance, etc...).

- 1** If switched-off, switch the sterilizer ON. If the clean water tank is almost empty, an alert appears on the display.
- 2** Open the chamber door.
- 3** Fill the clean water tank with a water container (app. 1.27 gal [4.8 l]).
Notice: The water must be demineralized or distilled meeting the specifications listed in these instructions (see "Water quality" on page 100 and "Feed water specifications (ANSI/AAMI and AAMI TIR34)" on page 100). Do not add any chemical / additive to the water.
Notice: Take care not to pour the clean water out of the tank; always refer to the notch on the clean water inlet.
- 4** Once the clean water tank is almost full, an audible tone sounds; stop filling.

DRAINING THE USED AND CLEAN WATER TANKS

Notice:

Before carrying out the following steps, make sure that the sterilizer has completed the cycle in progress.

Always wear appropriate PPE during use of the sterilizer (e.g. gloves for cleaning, maintenance, etc...).

- 1 If the used water tank is almost full, an alert appears on the display.
- 2 Open the service door at the front of the sterilizer.
- 3 Put a container (1.45 gal [5.5 l] min) below the sterilizer and insert into it the free end of the drain tube.
- 4 Plug the other end of the drain tube into the drain connector until it clicks. Make sure that the connector is firmly engaged. Use left connector (blue, 1) for the clean water and the right connector (grey, 2) for the used water.
- 5 Let the water flow from the tank completely.

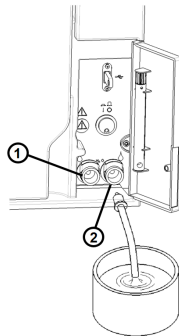

- 6 Press the push-button on top of the quick connector to dislodge the drain tube.

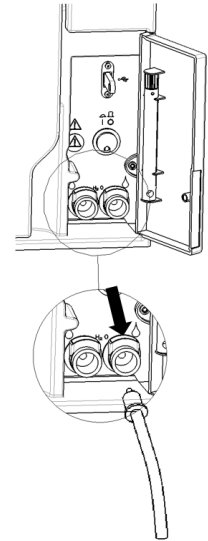

LAN CONNECTION

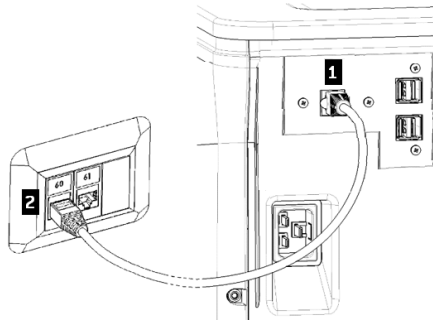

- 1 Insert a standard Ethernet cable in the LAN port of the sterilizer.
- 2 Insert the other end of the cable in the LAN port of your computer or computer network: when the sterilizer will be switched on it will connect automatically to the LAN.

WI-FI CONNECTION

For the Wi-Fi connection proceed as follows:

- 1 Insert the Wi-Fi dongle key in the USB port.
- 2 Read the Instructions for Use provided with the Wi-Fi dongle key.

INSTALLING THE STERILIZER



WARNING! In case of sterilizer malfunctions immediately unplug the sterilizer and call for service. Do not attempt to repair the sterilizer by yourself.

Notice:

Please ensure that all installation requirements are met before plugging the sterilizer. See "Connection diagrams" on page 99. No other devices should be connected to the sterilizer power panel circuit.

- 1 Place the sterilizer on a sturdy, flat and level surface.
- 2 Open the chamber door, remove all items from the sterilizer chamber except the chamber rack. Remove all plastic covers from trays.
- 3 Connect the auto-fill and auto-drain tubes in the rear of the sterilizer.
- 4 Connect the Ethernet cable or the Wi-Fi dongle key in the rear of the sterilizer.
- 5 Attach the power cord to the socket in the rear of the sterilizer and route the cord through the cable guides.
- 6 Connect the power cord to a wall outlet. For power supply requirements, see "Technical data" on page 97.

Operating the sterilizer

POWER THE STERILIZER ON/OFF

- 1 Press the power switch behind the service door: once switched ON, the visual indicator on the power switch turns green.

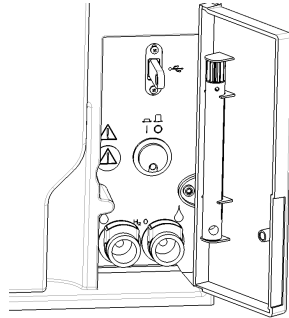

- 2 After a quick autotest the sterilizer automatically turns in Standby mode. See "Standby mode" on page 37.

Note: at the first start-up of the sterilizer, the Guided Configuration procedure automatically appears; see "Sterilizer setup" on page 34

- 3 Tap ①. The homepage appears with the enabled sterilization cycles.



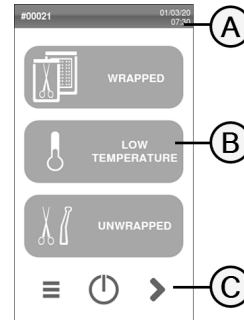





HOMEPAGE DESCRIPTION











Part	Description
A	Title/purpose of the screen, or the cycle number and the current date and time.
B	Available cycles and tests.
C	Additional buttons used to navigate the menu.







User interface menu









MAIN MENU FUNCTIONS

Icon	Label	Function
	Menu	Opens the menu.
	Cycle History	Shows all the sterilization cycles.
	Save	Saves all the sterilization cycle reports in the USB pen drive.
	System Info	<ul style="list-style-type: none"> ■ Shows the system information ■ During a cycle, shows the cycle parameters.
	Settings	Opens the pages to sterilizer management.
	Traceability	<p>Opens the pages to:</p> <ul style="list-style-type: none"> ■ monitor the performed cycle data; ■ manage users; ■ set the label printing options.
	Accessories	Opens the pages to accessories management.
	Maintenance	Carries out the maintenance procedure.

SETTINGS MENU FUNCTIONS







Icon	Label	Function
	Device	Opens the pages to set the device.
	Language	Sets device language.
	Date & Time	Sets date and time format, current date and time and time zone.
	Sterilizer Name	Sets the sterilizer name.
	Energy Management	Changes the standby mode delay.
	Display	Sets the display brightness.
	Audio	Manages the sterilizer sounds.
	Cycle	Opens the pages to manage cycles.





Icon	Label	Function
	Cycle Exclusion	Sets the cycles menu.
	Measurement Units	Sets the unit of measure.
	Daily Cycle Program	Programs a sequence of cycles to be run on daily basis.
	Connectivity	Opens the pages to manage the network connection.
	Ethernet	Manages the Ethernet network.
	WI-FI	Allows wireless network selection and configuration.
	Network Status	Only with a network connection set. Provides information about the network status.

Icon	Label	Function
	ioDent	Only if this service is supported in the country of use, and if the sterilizer is connected to it. Shows the status of the connection with the W&H monitoring server.
	Eliso Status	
	Akidata status	
	Remote Data Storage	Only with a network connection set. Opens the page to manage the remote storage.
	Settings	Only with a network connection set. Sets the parameters of the network location.
	Save all	Only with a network connection set. Copies all the files in the specified location in the network.
	Test	Only with a network connection set. Checks if the files can be copied to the specified location.
	USB options	Enables/disables USB warning messages.
	Traceability Settings	Chooses if the sterilizer is master or slave.



Icon	Label	Function
	Guided Configuration	Allows to start the configuration of: <ul style="list-style-type: none"> language; network connection; time zone settings; date & time settings; sterilizer name.







TRACEABILITY MENU FUNCTIONS



Icon	Label	Function
	Cycle History	Shows all the sterilization cycles and tests and prints reports and labels.
	Save	Saves all the sterilization cycle reports in the USB pen drive.
	User Management	Permits manage the users.
	Add User	Administrator only. Adds a user.
	Delete User	Administrator only. Deletes a user.
	Reset user PIN code	Administrator only. Resets a user PIN code.

Icon	Label	Function
	Change your PIN code	Changes the PIN code.
	Options	Administrator only. Permits the following: <ul style="list-style-type: none"> Identifies and saves the operator who starts the cycle and releases the load. Protects with a password the cycle start, the cycle stop and the load release.
	EliTrace	Allows to manage the instrument database.
	Label Printer	Optional, activated with an activation code. <ul style="list-style-type: none"> Sets the maximum storage time of the wrapped sterilized items. Sets the automatic or manual printing of the labels.



ACCESSORIES MENU FUNCTIONS

Icon	Label	Function
	USB Pen Drive	Opens the formatting page of the USB pen drive.
	Format	Formats the USB pen drive.
	Label Printer	Optional, activated with an activation code. Permits to select the label printer and sets the printout layout.









Icon	Label	Function
	Local Printer	Selects a printer connected to the sterilizer.
	Shared Printer	Selects a printer connected to another sterilizer (connected via local network)
	Calibration	Adjusts the label printer to the edge of the label.
	Test	Prints a test label.
	Printer	Selects the printer model connected to the sterilizer. The icon appears disabled if the printer/Ethernet cable/Wi-Fi dongle key is not connected.
	Special Codes	Saves the codes issued by the manufacturer to activate special functions. Note: only for technical support..









Icon	Label	Function
	Chamber Cleaning	<ul style="list-style-type: none"> ■ Shows the status of the cleaning operations; ■ Resets the cycle counter; ■ Displays the cleaning procedure videos.
	Tank Cleaning	
	System Update	Installs and upload the software.







MAINTENANCE MENU FUNCTIONS





Icon	Label	Function
	Bact. Filter	<ul style="list-style-type: none"> ■ Shows the status of the consumables; ■ Resets the cycle counter; ■ Displays the consumable replacement procedure videos.
	Door Gasket	

COMMON COMMANDS AND ICONS

Icon	Function
	Enters/exits the standby mode.
	Moves to the previous/next screen.
	
	Indicates that the chamber door is locked.
	Indicates that the chamber door is locking/unlocking.
	
	Indicates that the chamber door is unlocked and can be open.
	Copy the error log/reports to the USB pen drive.
	

Icon	Function
	Gives information about the current function.
	Opens the homepage.
	Accesses to the sub-menus.
	Opens a screen with other settings/options.
	Provides access to the SETTING screen of a specific area.
	Shows the list of all operating parameters of the sterilizer.
	Shows a sterilization summary.
	Indicates the value that may be changed and appears by clicking on it.
	Confirms the active option and saves a setting or a parameter.

Icon	Function
	<ul style="list-style-type: none"> Aborts the action/function. Moves to the previous screen without confirming/making any changes nor saving any parameters.
	Indicates that the option is ON and allows to set it OFF by touching it.
	Indicates that the option is OFF and allows to set it ON by touching it.
	Shows the error log.
	Confirm the active option. Saves a setting or a parameter. Answers YES to a question.
	Aborts the action/function. Moves to the previous screen without confirming/making any changes nor saving any parameters. Answers NO to a question.

Icon	Function
	Increases/decreases the value.
	Indicates that the option is active/not active.
	Indicates that the option is enabled/disabled.
	Show an animation about the replacement procedure.

Sterilizer setup

GUIDED CONFIGURATION





At the first start-up of the sterilizer, the Guided Configuration procedure automatically appears; this procedure allows to set some parameters of the unit, such as:

- Language
- Network connection (where applicable)
- Time zone settings
- Date & time settings
- Sterilizer name

At any time, to force the Guided Configuration:





- 1** On the homepage, tap  >  > 
- 2** Follow the Guided Configuration on the sterilizer screen.

SET THE LANGUAGE

- 1** On the homepage, tap  >  >  > 
- 2** Tap the language you prefer.
- 3** Tap  to confirm and go back to the homepage.





SET THE DATE AND TIME

To change the date and time format, current date and time zone:

- 1** On the homepage, tap  >  > 
- 2** Tap the value you want to change (format, time, date and/or time zone).
- 3** Tap the desired value.
- 4** Tap  to confirm and go back to the previous page.







SET THE STERILIZER NAME

To change the sterilizer name that appears in the cycle reports:

- 1** On the homepage, tap  >  > > > 
- 2** Tap the text box: a keyboard appears.
- 3** Enter the new sterilizer name.
- 4** Tap  to confirm.







SET THE DISPLAY BRIGHTNESS



To change the display brightness:

- 1** On the homepage, tap  >  > 
- 2** Tap  or  to change the value.
- 3** Tap  to confirm.



CONNECT TO A NETWORK

If you connect through an Ethernet cable, in most cases the sterilizer will connect to the network automatically. If it does not connect automatically, or if you are using a Wi-Fi dongle key, follow the following procedure under supervision of your IT manager / network administrator.

- 1 On the homepage, tap  >  > .
- 2 If the connection is through the Ethernet cable, tap : the TCP/IP screen appears.
- 3 If the connection is through Wi-Fi dongle key, tap : after a while, the sterilizer shows the available networks found. Choose the network, enter the credentials in the following screen, then tap  to confirm: the TCP/IP screen appears.

Note: the  and  icons are disabled if the connectivity means (cable or Wi-Fi dongle key) are not properly plugged.

Note: in the TPC/IP screen, the  icon is visible only if you make any change. The Wi-Fi icon at the bottom isn't visible if you connect through Ethernet cable.

- 4 If your network supports dynamic IP addresses (ask your IT manager), enable the options **Dynamic** both in **IP Configuration** and in the **DNS Configuration** fields, then tap  to confirm: all entry fields are disabled.
- 5 If your network does not support dynamic IP addresses (ask your IT manager), enable the options **Static** both in **IP Configuration** and in the **DNS Configuration** fields. Tap on each entry field and enter the IP addresses (ask your IT manager for details). Then tap  to confirm.

User authentication (optional)

FUNCTION AVAILABILITY

To access the user management functions a special code must be entered. The special code is required only at the first access to the **User Management**  menu: after the code was entered, the function is enabled and there is no need to enter the code again. If you want to disable the function another special code must be entered.









Note: for more information contact your dealer.

PIN MANAGEMENT

PIN "0000" is assigned as default to each new user. It has to be changed at the first login. When the PIN is reset the default value "0000" is reassigned.

CHANGE YOUR PIN

Change your PIN the first time you use the sterilizer and if your PIN has been reset. This will prevent other users to use your account.

- 1 On the homepage, tap  >  > 
- 2 Tap your user name.
- 3 Enter your current PIN and tap  to confirm.
- 4 Tap .
- 5 Enter your new PIN and tap  to confirm: a confirmation message with your new PIN appears.
- 6 Tap  and then  to go back to the previous page.

WHAT TO DO IF YOU FORGET YOUR PIN

If...	Then...
you are a common user	contact the administrator
you are the administrator	contact your authorized service provider

EliTrace (optional)

FUNCTION AVAILABILITY

To access the EliTrace functions a special code must be entered. The special code is required only at the first access to the **EliTrace**  menus: after the code was entered, the function is enabled and there is no need to enter the code again.

If you want to disable the function another special code must be entered.



Note: for more information contact your dealer.

DESCRIPTION

EliTrace allows to know exactly which instruments were sterilized and link them to a specific cycle.

ACCESS TO ELITRACE

For the EliTrace access proceed as follows:

- 1 On the homepage tap  >  > 

Note: for more information see the dedicated documentation.





USB pen drive

DESCRIPTION

A USB pen drive is available to be installed in order to automatically record all the sterilization cycle reports. The USB pen drive can be inserted equally into the front or rear port.

Notice: Periodically remove the USB pen drive to save the cycle data on a computer or on another safe support.

FORMAT THE USB PEN DRIVE

- 1 On the homepage, tap  >  > .
- 2 Insert the USB pen drive in one of the two USB ports.
- 3 Tap  .
- 4 Tap  to confirm: all data will be erased.

Notice: Formatting erases all data from the pen drive. Be sure you have already saved your data on a safe support before formatting.

Standby mode

DESCRIPTION

When in Standby mode, the sterilizer display remains dark and the sterilizer chamber is not heated to save energy. If the sterilizer is not used for three hours, it automatically switches to Standby mode.







ENTER THE STANDBY MODE MANUALLY

- 1 Homepage
- 2 Tap .

EXIT THE STANDBY MODE

Tap  or open or close the chamber door.

CHANGING STANDBY MODE DELAY TIME

- 1 On the homepage, tap  >  > .
- 2 Tap  or  to change the delay time.
- 3 Tap  to confirm.

Administrator

CONTENTS

This section deals with the following subjects:

User management (optional)	38
Traceability options (optional)	39
Hide/Unhide a cycle	40

User management (optional)

FUNCTION AVAILABILITY











To access the user management functions a special code must be entered. The special code is required only at the first access to the **User Management**  menu: after the code was entered, the function is enabled and there is no need to enter the code again. If you want to disable the function another special code must be entered.

Note: for more information contact your dealer.





WHO CAN MANAGE USERS AND RESET THEIR PIN

Only a user with administrator rights can create and delete users and reset the PIN code of a user to "0000".





ADD A USER

- 1 On the homepage, tap  >  > 
- 2 Tap your user name.
- 3 Enter the PIN and tap  to confirm.
- 4 Tap .
- 5 Tap the text box: a keyboard appears.
- 6 Enter the new user name and tap  to confirm.
- 7 If desired, tap to give the administrator authority to the new user.
- 8 Tap  to confirm: the PIN of the new user is set to "0000" and a confirmation message appears.
- 9 Tap  and then  to go back to the previous page.
- 10 Tap  to return to the homepage.

DELETE A USER

- 1 On the homepage, tap  >  > .
- 2 Tap your user name.
- 3 Enter the PIN and tap to confirm.
- 4 Tap .
- 5 Tap the user name you want to delete.
- 6 Tap to confirm.

RESET A USER PIN

- 1 On the homepage, tap  >  > .
- 2 Tap your user name.
- 3 Enter the PIN and tap to confirm.
- 4 Tap  and the user name for which you want to reset the PIN.
- 5 Tap to confirm: the PIN is set to "0000" and a confirmation message appears.
- 6 Tap  to return to the homepage.

Note: Remember the user to change their PIN before reusing the sterilizer.

Traceability options (optional)

FUNCTION AVAILABILITY





To access the user management functions a special code must be entered. The special code is required only at the first access to the **Options**  menus: after the code was entered, the function is enabled and there is no need to enter the code again. If you want to disable the function another special code must be entered.

Note: for more information contact your dealer.

WHO CAN SET THE TRACEABILITY OPTIONS

Only a user with administrator rights can set the traceability options.

SET THE TRACEABILITY OPTIONS



- 1 On the homepage, tap  >  > .
- 2 Tap your user name.
- 3 Enter your PIN and tap to confirm.
- 4 Tap the information to be requested to the users at the beginning and at the end of the cycle.
- 5 If you want the user to check the load and release it as valid at the end of the cycle, tap .
- 6 Tap  to confirm and go back to the previous page.

Hide/Unhide a cycle

WHO CAN HIDE/UNHIDE A CYCLE

Only a user with administrator rights can hide a cycle or make it available to users on the homepage.

HIDE/UNHIDE A CYCLE

1 On the homepage tap  >  > > > 

2 Tap your user name.

3 Enter your PIN and tap  to confirm.

4 Tap  to hide a cycle from the homepage.

5 Tap  to unhide a cycle from the homepage.

6 Tap  to confirm and go back to the previous page.

Managing printers

CONTENTS





This section deals with the following subjects:

Printer selection (optional)	41
Label printer selection (optional)	41
Label printer usage (optional)	42
Label content description	44

Printer selection (optional)

SELECT THE PRINTER

Note: The sterilizer only supports the specific printer models available through manufacturer/distributor.

- 1 On the homepage, tap  >  > > > 
- 2 Tap the model of the printer to use.
- 3 Tap  to confirm and go back to the previous page.

Label printer selection (optional)









FUNCTION AVAILABILITY

The first time you access the **Label Printer**  menu, you will be requested to enter an activation code. To require the activation code, please refer to the activation code instructions provided with the label printer.

LABEL PRINTER SETUP

Labels can be printed by a local label printer or (only with a LAN connection set) a shared label printer. The local label printer is connected to the sterilizer, while the shared label printer is connected to another sterilizer in the network.







SELECT AND CALIBRATE A LOCAL LABEL PRINTER

- 1 On the homepage, tap  > > > .
- 2 Tap : the local printer is located automatically.
- 3 Tap  to center the printout properly in the label area.
- 4 Tap  to print a test label.
- 5 If the printout is not duly centered, tap  or  to center it horizontally {x} and vertically {y}.
- 6 If necessary, tap  to print another test label and repeat step 4.
- 7 Tap  to confirm the settings and go back to the previous page.

SELECT A SHARED LABEL PRINTER

Note: Function available only if the LAN/Wi-Fi connection has been activated [optional].

- 1 Ensure the sterilizer to which the printer is physically connected is ON and no cycle is running.
- 2 From that sterilizer, tap  > .

- 3 Depending on the LAN connection, take note of the Ethernet or Wi-Fi IP address.
- 4 Do not switch OFF the sterilizer until the whole procedure is complete.
- 5 From the sterilizer from which the printer is not physically connected, tap homepage >  >  > > > .
- 6 Tap .
- 7 Tap the text box and enter the IP address previously noted.
- 8 Tap  to confirm.
- 9 From the sterilizer to which the printer is connected, confirm the printer sharing.
- 10 Tap  again to print a test label.

Label printer usage (optional)



CAUTION! For your safety and the safety of your patients use a storage time compliant with the recommendations of the manufacturers of the containers/packaging used, and with applicable norms and rules.

FUNCTION AVAILABILITY

The first time you access the **Label Printer**  menu, you will be requested to enter an activation code. To require the activation







code, please refer to the activation code instructions provided with the label printer.

AUTOMATIC PRINTING OPTION

The automatic printing option permits to automatically print a preset number of labels after a successful sterilization cycle. The labels are printed only after the user has identified him/herself (with password if required) and the load has been checked and released, if these options have been enabled by the administrator.





For the automatic label printing, a maximum storage time in weeks can be set. This value is used to calculate the expiry date to be printed on the labels (see "Label content description" on the next page).

SET THE AUTOMATIC LABEL PRINTING

- 1 On the homepage, tap  > > >  > 
- 2 Activate **Automatic printing**.
- 3 Tap  or  to set the maximum storage time and the number of labels to be printed automatically.
- 4 Tap  to confirm and go back to the previous page.





SET THE MANUAL LABEL PRINTING

The manual printing option permits the user at the beginning of a sterilization cycle to set manually the number of labels to print.

- 1 On the homepage, tap  > > >  > 
- 2 Activate **Manual printing**.
- 3 Tap  to confirm and go back to the previous page.

DISABLE THE LABEL PRINTING

If the label printing is disabled, no label can be printed at the end of a sterilization cycle.

- 1 On the homepage, tap  > > >  > 
- 2 Activate **Disabled**.
- 3 Tap  to confirm and go back to the previous page.

Label content description

STRUCTURE

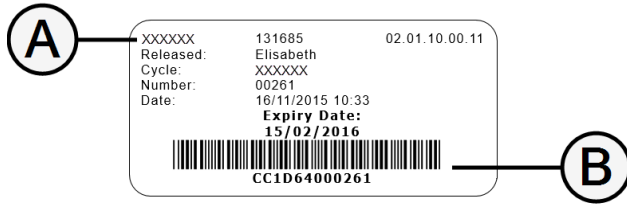

Part	Description
A	<ul style="list-style-type: none"> ■ Sterilizer model ■ Serial number ■ Software release
B	Traceability code (alphanumerical and bar code)
Released	Depending on the traceability settings, this field may contain one of the following elements: <ul style="list-style-type: none"> ■ the user who released the cycle ■ the user who started the cycle ■ the sterilizer ID
Cycle	Cycle name
Number	Cycle number
Date	Date and time of cycle start
Expiry date	<ul style="list-style-type: none"> ■ Expiry date of the bag/package. ■ The cycle outcome if a storage time is not set.

Sterilizer tests

CONTENTS

This section deals with the following subjects:

Sterilizer performance tests	45
Bowie and Dick test	45
Vacuum test	47

Sterilizer performance tests

TESTS THAT CAN BE PERFORMED ON THE STERILIZER

Test	Purpose	Reference
Bowie and Dick test	Validate the sterilizer performance for textile load sterilization.	See "Bowie and Dick test" below.
Vacuum test	Validate the sterilizer performance in terms of: <ul style="list-style-type: none">■ efficiency of the vacuum pump■ tightness of the pneumatic circuit	See "Vacuum test" on page 47.

Bowie and Dick test



CAUTION! Follow local/national guidelines on the frequency of testing.

PURPOSE OF THE TEST

The test is used to validate the sterilizer performance for textile load sterilization.

DESCRIPTION



It consists of several sheets of paper wrapped in a small packet with a chemical heat-sensitive indicator sheet in the middle. The colour assumed by this indicator sheet at the end of the sterilization cycle gives the result of the test.

CARRY OUT THE TEST

Note : carry out the test according to the local Regulations and the instructions of the PCD manufacturer.

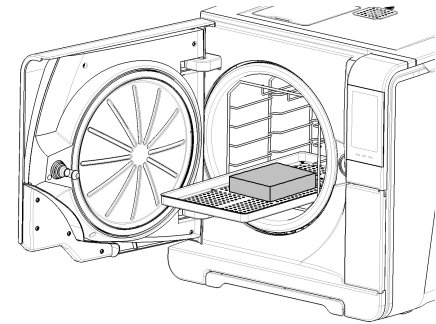
- 1** Empty the sterilizer chamber to ensure no load is present. Remove all trays from the sterilization chamber, except the lowest one.
- 2** Place the Bowie and Dick test pack in the center of a tray in the lowest rack position and close the chamber door.



- 3** On the homepage, tap **B&D test**.
- 4** To set the duration of the Plateau/Sterilization phase and other settings, tap .
- 5** Tap  and enter your credentials if required: the chamber door locks.
- 6** Wait until the end of the test and tap **OPEN**: the chamber door unlocks.
- 7** Enter your credentials if required.

- 8 Open the chamber door, extract the tray using the tray holder and take the test pack. The test pack can be wet outside.



CAUTION! Risk of burns. The test pack is very hot at the end of the cycle. Wear appropriate PPE (e.g. gloves).

- 9 Remove the indicator sheet from the center of the test pack and check the change in colour. See "Bowie and Dick test" on page 45

Note : for interpreting the test result follow the instructions of the PCD manufacturer.

Vacuum test



CAUTION! Follow local/national guidelines on the frequency of testing.

Notice: If a drainage period of the Unwrapped cycle is still operating, wait the drainage to be finished and the sterilizer to be both cold and dry. Otherwise, a false negative outcome could occur.

PURPOSE OF THE TEST

The test is used to validate the sterilizer performance in terms of:

- efficiency of the vacuum pump
- tightness of the pneumatic circuit

DESCRIPTION

It consists of a vacuum phase, followed by a stabilization period of 5 minutes and a testing period of 10 minutes. The internal pressure is monitored during the testing period. The pressure rise must be less than 0.013 bar (0.19 psi).

CARRY OUT THE TEST

- 1 Empty the sterilizer chamber to ensure no load is present.
- 2 Close the chamber door and ensure the sterilizer chamber is completely dry and cold to avoid any false negative outcome.
- 3 On the homepage, tap **Vacuum test**.
- 4 Tap  and enter your credentials if required: the chamber door locks.
- 5 Wait until the end of the test and tap **OPEN**: the chamber door unlocks.
- 6 Enter your credentials if required: a message informs if the test passed or failed. If the test failed, see "What to do when the test failed" below

WHAT TO DO WHEN THE TEST FAILED

- 1 Check, clean or replace the door gasket.
- 2 Clean the chamber face side and the chamber filters.
- 3 Repeat the Vacuum test. See "Carry out the test" above.
- 4 If the test fails repeatedly, call technical service.

Sterilization cycles

CONTENTS

This section deals with the following subjects:

Load maintenance and preparation	49
Typical loads	51
Prepare the sterilizer	52
Sterilization cycle description	53
Sterilization cycle management	54
Unloading	59
Sterilization cycle report	59

Load maintenance and preparation

WARNINGS



WARNING! Any residual of chemicals (like cleaning and disinfection products), could affect the purity of the steam and consequently the whole sterilization process. If necessary, the load shall be cleaned and lubricated in accordance with the instrument manufacturer's instructions.

Notice: Any residual of chemicals could seriously damage the sterilizer. The manufacturer's warranty is void in case of damage caused by chemicals.

DENTAL HANDPIECE EXTERNAL DISINFECTION

This procedure reduces the risk of infection during cleaning and maintenance of the dental handpieces.

- Wear protective gloves during disinfection.
- Avoid using abrasive disinfectants (pH-value 2.5 – 9; no chlorine based disinfectants).
- Use disinfectant wipes rather than spray disinfection.
- Do not immerse handpieces in disinfectants.
- Residual disinfectants on handpieces can cause extensive damage to your instrumentation during sterilization (oxidation, alteration of technical characteristics of seals, rubbers, fiber optics, etc.).

DENTAL HANDPIECE EXTERNAL CLEANING

This procedure involves the removal of residues (blood, dentine, etc.) that adhere to critical areas such as spray outlets, light ports, knurling etc.

- Wear protective gloves during cleaning.
- Refer to the instructions of the instrument manufacturer.
- Use a soft, damp brush and take care not to scratch the surface of the light ports.

DENTAL HANDPIECE LUBRICATION

Once the dental handpieces has been disinfected, cleaned and dried (free from residues), it must be lubricated prior to sterilization. Follow manufacturer's instructions for proper lubrication.

PACKAGING

In order to preserve sterility, rotating instruments should be wrapped/bagged prior to sterilization. Follow the manufacturer's packing instructions when using sterilization packaging.

CLEANING THE INSTRUMENTS

Clean all instruments thoroughly prior to sterilization. If possible, clean instruments immediately after use; always follow the instrument manufacturer's instructions. Remove all traces of disinfectants and detergents. Rinse and dry carefully all instruments.

The instruments and tubes must be carefully rinsed and dried prior to sterilization.

CORRECT LOAD PLACEMENT



WARNING! Do not overload trays and the chamber. Adhere to the maximum load weight limits (see "Sterilization programs" on page 90). Never place the load or the trays directly into the chamber without the chamber rack as this could affect the steam and temperature distribution. The load must always be supported by the chamber rack. Risk of burns. Before touching, ensure the sterilization chamber is cold.



Wrap items with porous wrapping materials to facilitate steam penetration and drying (e.g. sterilization bags for autoclaves). Always use the chamber rack to allow adequate steam circulation.

Follow these requirements:

Load type	Placement
Hinged instruments (e.g., forceps, extraction pliers, etc.)	In open position
Tubes	Place tubes on a tray allowing the ends to remain open. Do not bend tubes.
Cassettes	Cassettes can be placed vertically or horizontally into the chamber rack (vertical placement enhances drying). When placing cassettes horizontally, slide them into the rack position without putting them on trays (if size allows) to enhance drying. When sterilizing double-decker cassettes, place them in the lowest rack position as there is more space height-wise.

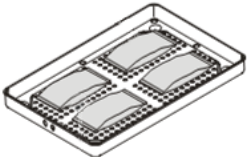
Load type	Placement
Pouched items	On trays allowing adequate space in-between bags. Ensure that packs do not touch the walls of the chamber. Place sterilization pouched items with the paper side facing up. 
Items made from different materials (stainless steel, carbon steel, aluminium, etc.)	On separate trays or wrapped/pouched
Instruments manufactured from carbon steel	Place paper among them and the trays to avoid rusty spots

PARTIAL LOAD

If the chamber is just partially loaded, place the load in such a way that the space in-between the trays is maximized. Spread items evenly on multiple trays. Below is a example with three trays.

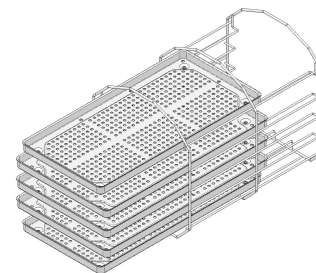

Typical loads

EXAMPLES

An example of a typical load used during the tests performed by W&H is reported below:

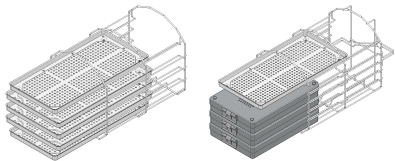
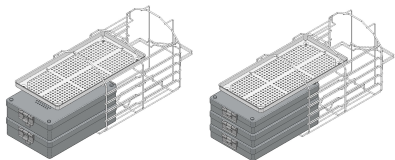
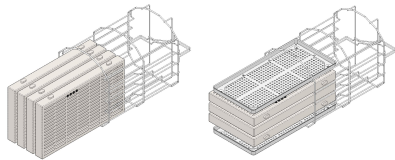
Program	Load example
Wrapped Low Temperature Unwrapped	
	
	

Prepare the sterilizer

WARNINGS

Notice: Use only distilled or demineralized water (see "Water quality" on page 100 for technical requirements). Do not add any chemical /

additive to the water.

FILLING THE CLEAN WATER TANK

If no water system is connected you have to fill the tank:

- 1** Switch the sterilizer ON and open the chamber door.
- 2** Fill the clean water tank with distilled or demineralized water until the sterilizer makes a sound. See "Technical data" on page 97 for the tank volume.

INSERTING THE CHAMBER RACK INTO THE STERILIZER





CAUTION! Risk of burns. Before touching the chamber rack or contents, ensure the sterilization chamber is not hot.

- 1** Open the chamber door and align the chamber rack at the center/bottom of the chamber.
- 2** Push the chamber rack gently into position until it clicks into place.
- 3** Insert cassettes horizontally or vertically, or insert trays. See "Load maintenance and preparation" on page 49 for load requirements and "Chamber accessories" on page 22.
- 4** Close the door.
- 5** Turn the sterilizer ON: after the initialization the homepage appears.

GENERAL RECOMMENDATIONS

Follow these recommendations to obtain the most from the drying:

- Ensure the paper side of the sterilization bags faces up, and that the space in-between bags is enough.
- To enjoy the full benefit of short cycle times when only one tray is used, always place the load on the upper tray of the chamber rack and remove all other trays from the chamber.



Icon	Mode	Description
	ECO DRY +25%	The drying time is automatically adjusted to the total amount of load with a 25% of additional drying duration.
	ECO DRY +50%	The drying time is adjusted to the total amount of load with a 50% of additional drying duration.

Sterilization cycle description

AVAILABLE STERILIZATION CYCLES

See "Sterilization programs" on page 90 for the full list of key program features, including sterilization time, temperature and recommended load type.

AVAILABLE ECO DRY MODES

Icon	Mode	Description
	ECO DRY plus	The drying time is automatically adjusted to the shortest possible for the total amount of load: the smaller the load, the faster the cycle. It ensures perfect drying of standard loads.
	ECO DRY	The drying time is automatically adjusted to the total amount of load. It is longer than the ECO DRY plus mode. It is useful with those particular loads that require an extended drying time [suggested for container load].

Sterilization cycle management





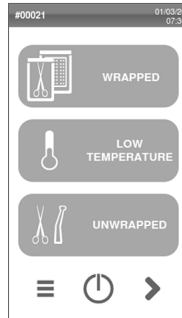

RUN A STERILIZATION CYCLE

Note: if the user management and the label printer functions are enabled, you might be requested to enter your PIN code during the following procedure.

- 1 On the homepage, tap the desired cycle.

Tap  to display further cycles on the next page, if any.



- 2 Check the cycle requirements.
- 3 Check the icon in the top left corner of the page to know the ECO DRY mode assigned to the cycle.
- 4 Tap  :
 - to change the ECO DRY mode (see "Change the ECO DRY mode" on page 57).
 - to disable the ECO DRY mode (see "Set the drying time" on page 57).
- 5 If the door gasket is new, hold the door gently closed until the beginning of the cycle.
- 6 Tap  and enter your credentials if required: the door locks. If you have not set a different start time, the sterilization starts immediately.
- 7 The sterilization is completed. Tap  to view the cycle summary (to check the cycles values manually, see "STERILIZATION CYCLE MONITORING" on the next page) or tap  to view the cycle information. See "View the cycle parameters" on page 57.
- 8 The sterilization is completed. Tap  to view the cycle summary or tap  to view the cycle information. See "View the cycle parameters" on page 57.
- 9 Tap **OPEN**: the door unlocks and the homepage appears.

10 If required, enter your credentials and confirm the load release.

Note: the load release is possible only if the cycle is completed successfully.

Note: the user visually checks that pouches are intact and dry. It is even possible to identify the user who releases the load.

Note: during the load release it is also possible to insert the chemical and biological indicator result (for US-CA version only).

STERILIZATION CYCLE MONITORING

Even if the sterilization process is automatically monitored by the software and the values of temperature, pressure and duration are controlled, there is the possibility to check the values manually. See the table below for the correct values of the temperature, pressure, and duration in order to confirm manually the proper execution of the cycle.

US - Canada version

	270 °F (132 °C) cycles	250 °F (121 °C) cycles
Duration (minutes)	4	30
Min. temperature	270 °F (132 °C)	250 °F (121 °C)
Max. temperature	275 °F (135 °C)	255 °F (124 °C)







	270 °F (132 °C) cycles	250 °F (121 °C) cycles
Min. pressure	26.68 psi at 270 °F (1.84 bar) at (132 °C)	14.9 psi at 250 °F (1.028 bar) at (121 °C)
Max. pressure	30.45 psi at 275 °F (2.1 bar) at (135 °C)	17.83 psi at 255.2 °F (1.23 bar) at (124 °C)

Standard version

	269.6 °F (132 °C) cycles	249.8 °F (121 °C) cycles
Duration (minutes)	4	30
Min. temperature	269.6 °F (132 °C)	249.8 °F (121 °C)
Max. temperature	275 °F (135 °C)	255.2 °F (124 °C)
Min. pressure	26.68 psi at 269.6 °F (1.84 bar) at (132 °C)	14.9 psi at 249.8 °F (1.028 bar) at (121 °C)
Max. pressure	30.45 psi at 275 °F (2.1 bar) at (135 °C)	17.83 psi at 255.2 °F (1.23 bar) at (124 °C)

SET THE STERILIZATION CYCLE START

You may schedule the start of the sterilization cycles at a certain date and time (e.g., if you want to load the sterilizer in the evening and run standard sterilization cycle early the next morning before office hours). You can set the cycle start date and time and enable or disable it for each cycle.











- 1 On the homepage, tap the cycle and .
- 2 Tap the leaf icon to set the ECO DRY mode.
- 3 Tap the ECO DRY mode you desire.
- 4 Tap  to confirm and go back to the previous page.
- 5 To change the start time, tap **Start cycle at**.
- 6 Tap the time or the date: a settings page opens.
- 7 Tap the number you want to change and tap  or  to increase it or decrease it.
- 8 Tap  to confirm and go back to the previous page. This date and time become the scheduled default start time for all next sterilization cycles.
- 9 Tap  to lock the door and start the countdown for the current cycle.

Note: You can decide to start the cycle immediately or stop the countdown at any time.







PROGRAM A SEQUENCE OF CYCLES TO RUN AUTOMATICALLY

It is possible to program the sterilizer in such a way that a sequence of cycles runs automatically at a preset date and time [e.g. if you want to run a vacuum test in the early morning before office hours]. Maximum two cycles can be programmed.

To program the sterilizer proceed as follows:



- 1 Load the chamber and close the chamber door.
- 2 On the homepage, tap  >  >  > 
- 3 Tap  to add a cycle to the list above.
- 4 Tap  and then the cycle you want to add.
- 5 Tap : the cycle is automatically listed in the previous page.
- 6 Tap the date/time to set the start of the cycle.
- 7 Tap the number you want to change and tap  or  to increase it or decrease it.
- 8 Tap  to confirm and go back to the previous page.
- 9 Repeat steps from 3 to 7 to add another cycle to the sequence.
- 10 Tap  to launch the programmed sequence.

DELETE A CYCLE FROM A PROGRAMMED SEQUENCE

- 1 On the homepage, tap  >  >  > 
- 2 Tap the cycle you want to remove from the sequence.
- 3 Tap  to remove the selected cycle.
- 4 Tap  to confirm and go back to the previous page.

SET THE DRYING TIME



For each ECO DRY mode, the drying time is automatically adjusted to the total amount of load and cannot be modified. To set a new drying time for the program, you should disabled the ECO DRY mode first.

- 1 On the homepage, tap the cycle and .
- 2 Select **Fixed** to disable the ECO DRY mode.
- 3 Tap the wording **Fixed** to modify the fixed mode minutes.
- 4 Tap  or  to increase the minutes or decrease them.

Note: for the minimum value of the drying time for each cycle see Sterilization cycles.



- 5 Tap  to confirm and go back to the previous page. This becomes the new fixed value.

CHANGE THE ECO DRY MODE

- 1 On the homepage, tap the cycle and .
- 2 Tap the leaf icon to set the ECO DRY mode.
- 3 Tap the ECO DRY mode you desire.
- 4 Tap  to confirm and go back to the previous page.
- 5 Tap  to go back to the homepage.

VIEW THE CYCLE PARAMETERS



You can check the real time cycle parameters or the cycle parameters at the end of the cycle. Following is an example:

- 1 While the sterilization cycle is running or when cycle ends tap  : the cycle information page opens.
- 2 Tap  or  to scroll the pages.

STERILIZATION CYCLE PAGE

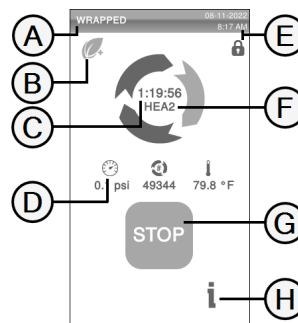

Following are the information displayed while a cycle is running:



Part	Description
A	Sterilization cycle name
B	Countdown clock (time until the cycle completion)
C	 : chamber pressure  : cycle counter  : chamber temperature
D	Date and time and door securely locked symbol
E	Current cycle phase
F	Stop button
G	Button to open the cycle information page

END OF A STERILIZATION CYCLE

When a cycle is successfully finished, the "Cycle completed" message appears on the screen. To end the cycle:

- 1 Tap  to view the cycle summary or tap  to view the cycle parameters. See "View the cycle parameters" on the previous page.
- 2 Tap **OPEN** to open the door: the door unlocks and the home page appears.

Note: if an error message appears see "Troubleshooting" on page 82



CAUTION! Hot surfaces. Burnings. Do not touch the chamber, the internal side of the door and the internal fittings. Use the tray holder or cassette holder or gloves for high temperatures or adequate protection to remove the load!

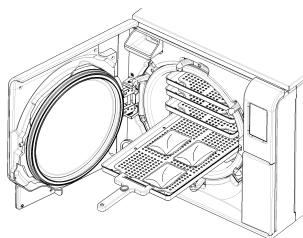



- 3 Open the chamber door.
- 4 Remove the load and stock it.

STOP A STERILIZATION CYCLE



WARNING! You can stop the cycle at any time. Instruments must not be considered sterile if this occurs before the **DRY phase**.

A cycle can be manually aborted at any time. To stop a cycle:

- 1 Tap **STOP**: a confirmation request appears.
- 2 Tap  to abort the stop command. The cycle continues programmed.
- 3 Tap  to abort the cycle: the sterilizer starts a reset phase.

Notice: Do not switch off the sterilizer during the reset phase: it takes some time to reset the system and reach safe conditions in the sterilizer chamber.

- 4 Check the message. See "Messages of a stopped sterilization cycle" on the next page.
- 5 Tap  to view the cycle parameters. See "View the cycle parameters" on the previous page.
- 6 Open the chamber door.
- 7 Reprocess the load if necessary.



CAUTION! Hot steam. Wait the steam to dissipate before opening the door.

Note: Water could be present in the chamber when opening the door. To prevent spilling place a towel below the chamber door.

MESSAGES OF A STOPPED STERILIZATION CYCLE

Following are the messages:

- Load not sterile: Do not use items on patients!
- Drying interrupted: The load might be wet. Wet items are for immediate use only!

Unloading

WARNINGS



CAUTION! Risk of burns. Before touching, ensure the sterilization chamber is cold. Always use the tray holder.

Sterilization cycle report

WHERE CYCLE DATA ARE STORED

The sterilizer stores in memory the summarized reports of the last 400 cycles and the analytical reports of the last 5 cycles. All reports can also be saved on the USB pen drive or in a specific remote folder in the network if the sterilizer is connected to a LAN .

STORED REPORT FORMAT



The summarized reports are stored in HTML format and the analytical reports in SCL format. All parameters are recorded every second.

WHAT HAPPENS WITH UNSAVED CYCLES



If for any reason (e.g. USB memory full, USB pen drive disconnected, etc.) some cycles cannot be saved, no alert is shown. If still stored in memory, the unsaved cycles will be copied in a working USB pen drive connected to the sterilizer as soon as a new cycle starts.

VIEW CYCLE HISTORY

To view the sterilization cycle history:







- 1** On the homepage, tap  > : all the sterilization cycles are listed with number, date, time and sterilization program.
- 2** Scroll the list and tap the desired sterilization cycle: the report opens.

PRINT OR SAVE A CYCLE REPORT ON THE USB PEN DRIVE

- 1** On the homepage, tap
- 2** Scroll the list and tap the desired sterilization cycle: the report opens.
- 3** Tap .
- 4** Tap  to print the report, or tap  to save the report on the USB pen drive.



PRINT LABELS FOR A SPECIFIC CYCLE

Note: Function available only with the Label printer activation code.

- 1 On the homepage, tap  > .
- 2 Scroll the list and tap the desired sterilization cycle: the report opens.
- 3 Tap .
- 4 Tap  to print traceability labels for the selected cycle.
- 5 Tap  or  to increase or decrease the number of label to be printed.
- 6 Tap to save the set number for the next time.
- 7 Tap to print the labels required.







SAVE ALL THE CYCLE REPORTS ON THE USB PEN DRIVE

The number of reports that can be saved on the USB pen drive depends upon the USB capacity. To save all the cycle reports:

- 1 On the homepage, tap  > .
- 2 Tap  : after the confirmation all sterilization cycle reports are stored in the USB.







SET THE REMOTE FOLDER FOR SAVING THE REPORTS

To activate the remote storage and set the necessary parameters do the following:

- 1 On the homepage, tap  >  >  > .
- 2 Tap  to enable the remote data storage: the first four fields in the page and the check box turn dark grey.
- 3 In **Path** enter the name of the shared folder followed by the sub-folder name, if any, where to save reports. Do not enter the full path.
Note: The folder name must include letters and numbers only. Do not use other characters like space-bar, slash, accent, etc.
- 4 Enter the host name or the IP address: if the data are complete, the fields highlight.
- 5 Not mandatory. Enter the domain name.
- 6 Tap to require the authentication credentials to access the remote storage folder and enter the user name and password.
- 7 Tap to save.
- 8 Tap  to go back to the previous page.
- 9 To check if the parameters entered are valid, see "Test the data storage " on the next page.

TEST THE DATA STORAGE





Note: The test function is available only if the remote data storage is enabled. See "Set the remote folder for saving the reports" on the previous page.

- 1 On the homepage, tap  >  > 
- 2 Tap : a sequence of tests is automatically performed.
- 3 In case a test fails, check the relevant settings and tap  to repeat the test sequence, if the error persists call your IT manager.
- 4 Tap  to go back to the previous page.

SAVE ALL THE CYCLE REPORTS IN A REMOTE FOLDER

Note: The save all function is available only if the remote data storage is enabled. See "Set the remote folder for saving the reports" on the previous page.

Only the last 400 cycles in HTML and 5 cycles in SCL in the sterilizer memory can be saved in the remote folder.

- 1 On the homepage, tap  >  >  > 
- 2 Tap  to start the remote saving.

CYCLE REPORT STRUCTURE

Following the structure of a cycle report:

Cycle Report				
W&H Sterilization Lexa Plus				
Serial Number:	190002			
SW version:	005.003.Z23			
Local ID:	Lexa Plus			
Cycle type:	WRAPPED			
Cycle log number:	01152			
Sterilizat. temp.:	270 °F			
Sterilizat. time:	04:00			
Cycle start at:	01-30-2021 12:00 AM			
Phase	Time	Duration	T [°F]	P [psi]
START	00:05	00:00	213	-1.0
PV1	02:42	02:37	201	-12.6
PP1	04:01	01:19	233	6.0
PV2	05:19	01:18	204	-12.2
PP2	06:51	01:32	231	5.9
PV3	07:54	01:03	205	-12.2
PPH	12:30	04:36	270	27.0
PRS	12:30	00:00	270	27.0
Exposure time: 04:00				
MIN T: 270 °F at 00:00				
MAX T: 273 °F at 00:42				
MIN P: 27.0 psi at 00:00				
MAX P: 29.2 psi at 00:41				
F0 value: 83 at 04:00				
PRE	16:30	04:00	273	28.8
DVS	16:30	00:00	273	28.8
D1	16:53	00:23	252	14.1
D2	17:46	01:16	207	-7.3
D36	37:59	21:29	186	-13.4
DVE	38:30	22:00	186	-13.6
DRY	38:30	22:00	186	-13.6
LEV	39:34	01:04	216	-0.6
END	39:34	00:00	216	-0.6
H2O: 232 cm ³				
F0: 83				
Cycle completed				
Cycle end at: 01-30-2021 12:40 AM				
Cycle time: 39:34				
Signature: _____				
Tracking #: CC2E63201152				

Data	Description
A	Sterilizer model
SN	Sterilizer serial number
Software rev.	Software revision number
Sterilizer Name	Surgery – practice – doctor name
Cycle	Name of the executed cycle
Number	Cycle counter
Sterilizat. temp.	Programmed sterilization temperature
Sterilizat. time	Programmed Plateau/Sterilization
Date (above)	Cycle start date and time
START	Cycle start
PV1, PP1, PV2, PP2, PV3	Pressure and vacuum pulses
PPH	Phase of pressure rise to sterilization conditions
PRS	Plateau/Sterilization phase start <ul style="list-style-type: none"> ■ MIN, MAX temperature ■ MIN, MAX pressure
PRE	Plateau/Sterilization phase end
DVS	Drying phase start
DRY	Drying phase end
LEV	Pressure leveling phase
END	Cycle end conditions

Data	Description
Cycle end at	Cycle end date and time
Cycle time	Cycle time
Signature	Operator signature
"Cycle completed"	Cycle outcome
Tracking	Tracking code for traceability management

Maintenance

CONTENTS

This section deals with the following subjects:

Warnings for maintenance operations	64
User maintenance	64
Monthly or 50-cycle maintenance	66
400-cycle maintenance	69
800-cycle or biannual maintenance	70
1200-cycle or yearly maintenance	73
Extraordinary maintenance	75
Disposal	76

Warnings for maintenance operations

WARNINGS



WARNING! Turn the sterilizer OFF and remove the power cord before beginning any maintenance. Follow all health, safety, cross-infection and cross-contamination protocols.

Maintenance operation shall be done at illumination level of 215 lx (± 15 lx) to 1500 lx (± 15 lx).

Before making any operation, ward off unauthorized personnel from the working area.



CAUTION! Before accessing the chamber and the connected parts, be sure that the sterilizer is cold.

Notice: Follow the instructions in this chapter when carrying out any maintenance on the sterilizer.

User maintenance

MAINTENANCE BY THE USER

Frequency ¹	Cycles ¹	Operation
Monthly	50	Cleaning the door gasket and the chamber face side. See "Cleaning the door gasket and the chamber face side" on page 66 Clean the chamber, trays and the rack. See "Cleaning the chamber and the chamber accessories" on page 67 Cleaning the chamber filters. See "Cleaning the chamber filters" on page 68 Cleaning the external surfaces of the sterilizer. See "Cleaning the external surfaces of the sterilizer" on page 68
6 month	800	Clean the clean water tank. See "800-cycle or biannual maintenance" on page 70

Frequency ¹	Cycles ¹	Operation
Yearly ²	400 ²	Replace the HEPA filter. See "400-cycle maintenance" on page 69.
Yearly ²	1200 ²	Replace the door gasket. See "Replacing the door gasket" on page 73

1: whichever occurs first.



2: even if the maximum cycle number is not reached, it is recommended to replace the consumable parts every year, or if they appear worn or damaged, or if the filters are clogged or discolored.

EXPIRED MAINTENANCE

The sterilizer monitors the wear of consumables by counting the number of cycles executed since the last replacement.





When the number of cycles is close to the maximum, a pre-alert about the concerned consumable is displayed. Please check that you have the requested spare part available, buy one if not. When the maximum number of cycles has been met, a message to replace the consumable will be displayed.

If you can not replace the consumable immediately, the sterilizer will operate anyway but the message will appear again some cycles later.

- 1 Tap  to see an animated replacement procedure.
- 2 When you have replaced the consumable tap  to confirm: the executed cycle counter is reset.

REPLACE THE CONSUMABLE BEFORE THE MAINTENANCE DUE DATE

If you replace the consumables before the request of replacement appears, you should manually reset the counters through the following procedure.

- 1 On the homepage, tap  > 
- 2 Select the consumable you want to replace: a message appears showing the current worked hours of the part.
- 3 Tap  to see an animated replacement procedure.
- 4 When you have replaced the consumable tap  to confirm: the executed cycle counter is reset.

Monthly or 50-cycle maintenance

CLEANING THE DOOR GASKET AND THE CHAMBER FACE SIDE

Proceed as follows:

- 1 Clean the door gasket and the outer edge of the chamber with a non-abrasive cloth moistened with clean water.

Notice:

Do not use abrasive products, cutting tools or sharp objects.

- 1 Rinse with clean water.

Note: when the seal is new it might be necessary to hold the door gently closed at the sterilization start.

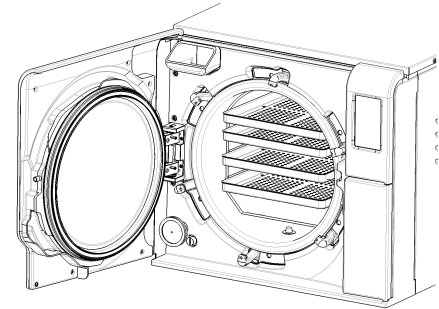

CLEANING THE CHAMBER AND THE CHAMBER ACCESSORIES

Proceed as follows:

- 1** Remove the trays and the chamber rack.
- 2** Clean the chamber with a damp sponge and a mild detergent solution paying attention not to bend or damage the temperature probe inside the sterilizer chamber.
- 3** Rinse with water.
- 4** Clean the trays and the chamber rack with a damp sponge and a mild detergent solution.
- 5** Rinse with water.
- 6** Reposition all pieces of the chamber accessories properly.

Note: The trays and the tray holder may also be cleaned in a washer disinfectant.

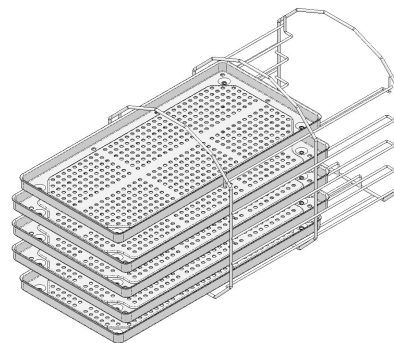

CLEANING THE CHAMBER FILTERS

Proceed as follows:

- 1 Allow the sterilization chamber to cool down.
- 2 Empty the sterilizer chamber by removing the trays and the rack.
- 3 Remove the filters at the bottom of the chamber (bottom/center) by unscrewing them.
- 4 Rinse the filters with tap water.
- 5 Insert the filters in their original position, screwing them into place.

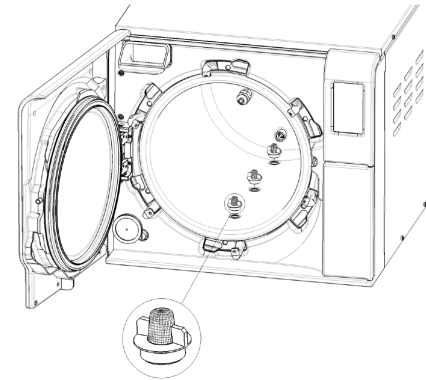

CLEANING THE EXTERNAL SURFACES OF THE STERILIZER

Proceed as follows:

- 1 Clean all external sterilizer covers with a slightly damp cloth moistened with water. For better cleaning results, clean with W&H MC-1000 cleaning solution.
Notice: never use any other disinfectant, detergent or abrasive product, as they might result aggressive for the external covers and damage them.

400-cycle maintenance

REPLACING THE HEPA FILTER

Notice: The HEPA filter needs to be replaced every 400 sterilization cycles or once a year, whichever come first. A replacement message alerts when replacement is due. If the consumables is replaced prior to the message, you have to reset the consumable cycle counter.

Proceed as follows:

- 1** Open the sterilizer door.
- 2** Unscrew the HEPA filter by hand (counter-clockwise).
- 3** Screw on the new HEPA filter (clockwise) and tighten it snug.

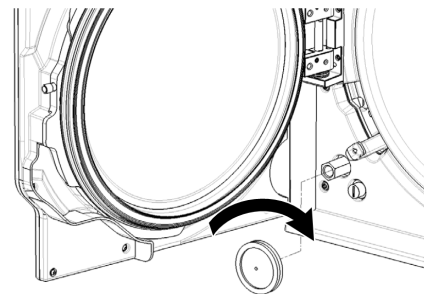

800-cycle or biannual maintenance

SEQUENCE OF PROCEDURES TO CLEAN THE WATER TANK

To clean the water tank, proceed as follows:

- 1 "Prepare the sterilizer for cleaning the water tank" below "Prepare the sterilizer for cleaning the water tank" below.
- 2 "Access to the water tank" on the next page" "Access to the water tank" on the next page.
- 3 "Clean the water tank" on page 72

PREPARE THE STERILIZER FOR CLEANING THE WATER TANK

Proceed as follows:

- 1 Switch OFF the sterilizer and disconnect the mains cable.
- 2 Completely drain both water tanks (see "Draining the used and clean water tank" on page 75).
- 3 To drain the detergent solution during the subsequent cleaning, leave the drain tube attached to the drain connection of the tank you want to clean.

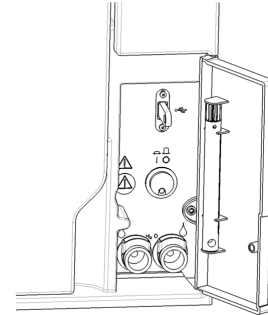

ACCESS TO THE WATER TANK

Proceed as follows:

- 1 Lift the water tank cover.

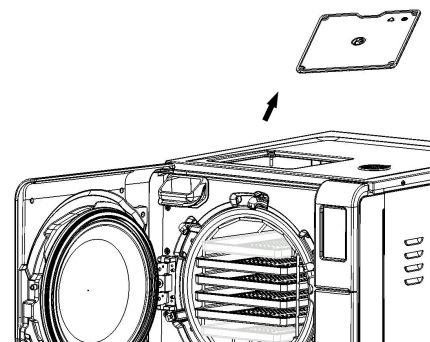

CLEAN THE WATER TANK

Notice: Do not touch the water level sensors. If misplaced or misaligned from their original position, the operation of the sterilizer could be impaired.

Proceed as follows:

- 1** Clean the internal tank surfaces with a soft sponge moistened with water. For better cleaning results, clean with W&H MC-1000 cleaning solution. Use a small non-abrasive brush to clean the areas that are difficult to reach.
Notice: never use any other disinfectant, detergent or abrasive product, as they might result aggressive for the tank material.
- 2** Rinse the internal tank surfaces thoroughly, until all residuals of dirt and detergent have been eliminated.
- 3** Dry the internal tank surfaces.
- 5** Remove the internal filter.
- 6** Clean the metal cartridge of the internal filter with tap water.
- 7** Reposition the internal filter.
- 8** Detach the drain tube.

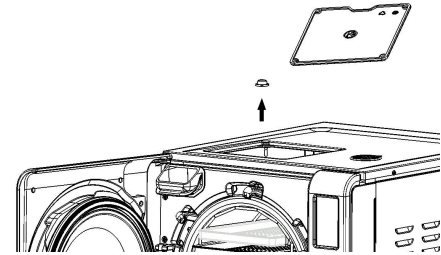

1200-cycle or yearly maintenance

REPLACING THE DOOR GASKET

Notice: The door gasket needs to be replaced every 1200 sterilization cycles or once a year, whichever come first. A replacement message alerts when replacement is due. If the consumables is replaced prior to the message, you have to reset the consumable cycle counter.

Proceed as follows:

- 1 Open the chamber door.
- 2 Remove the used door gasket by hand.
- 3 Carefully clean the seal seat and the inside face of the chamber door.

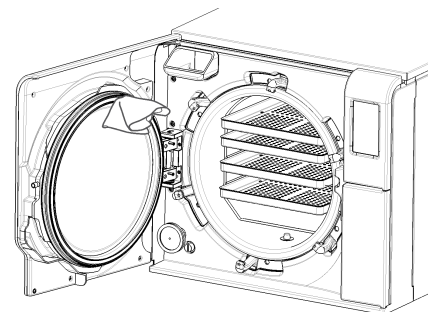

4 Insert the new seal and press first up and down.

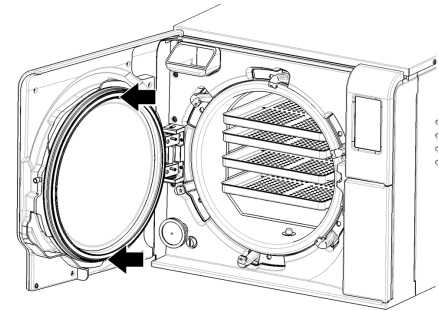

5 Press left and right.

6 Make sure the door gasket is seated evenly.

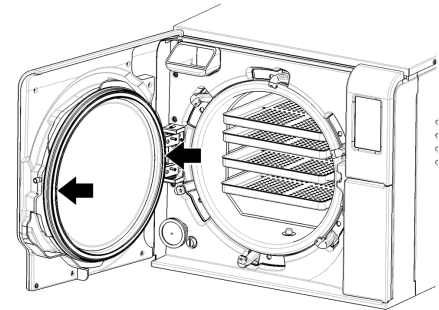

Extraordinary maintenance

DRAINING THE USED AND CLEAN WATER TANK

If you left accidentally the tanks full for more than seven days or if you plan not to use the sterilizer for at least seven days, you have to drain the tanks.

- 1** Open the sterilizer service door.
- 2** Put a container below the sterilizer (1.45 gal [5.5 l] minimum) and place the end of the drain tube in it.
- 3** To drain the used water, insert the drain tube connector in the grey connection.
- 4** To drain the clean water, insert the drain tube connector in the blue connection.
- 5** When the water has been completely drained, press the release button to remove the drain tube and close the service door.

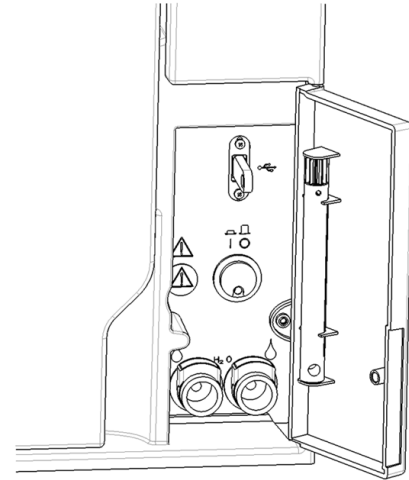

Disposal

DISPOSAL RESPONSIBILITY



- Separate the various components according to the materials they are made of
- Drop the sterilizer with a company that specializes on the recycling of related products
- Do not abandon the sterilizer in unsecured places
- Always refer to current/applicable laws and rules in the country of use

The same instructions apply to disposal of all used consumable parts.

MATERIALS

The sterilizer is mainly built from fiber-reinforced polymers, metals and electric / electronic components.

Diagnostics

CONTENTS

This section deals with the following subjects:

Errors	77
Troubleshooting	82
Emergency door opening	87

Errors

CHECKS AND ACTIONS

Notice: For any error not listed in this table, call technical service.

Code	Description	Actions
0xx	Load cannot be considered sterile. See "End of a sterilization cycle" on page 58	Repeat the cycle. If the problem persists, call service.
	Check if the mains switch or network circuit breaker is OFF.	
	Check if the mains cable is properly connected.	
	Switch the sterilizer OFF and ON.	
	Set date and time, then switch the sterilizer OFF and ON.	
	Ensure that the sterilizer fan is not blocked.	
10x	See error "13x to 16x" on the next page.	Repeat the cycle. If the problem persists, call service.

Code	Description	Actions
12x	Wait before opening the chamber door. Allow the sterilization chamber to cool down.	Repeat the cycle.
	Switch the sterilizer OFF and ON.	If the problem persists, call service.
	Clean the chamber and the chamber furniture from residuals of detergents, disinfectants and other chemicals.	
	Replace the clean water if it is suspected to be contaminated with chemicals. Ensure all the load is clean rinsed and free from any chemicals before sterilizing.	
13x to 16x	Check water level in the clean water tank. Reset the safety thermostat..	Repeat the cycle.
	Switch the sterilizer OFF and ON.	If the problem persists, call service.
	Clean the door gasket and the chamber face side.	
	Check if the load placed in the sterilization chamber complies with the MAXIMUM WEIGHT LIMITS.	
	Clean the chamber and the chamber furniture from residuals of detergents, disinfectants and other chemicals.	
	Replace the clean water if it is suspected to be contaminated with chemicals. Ensure all the load is clean rinsed and free from any chemicals before sterilizing. Start a vacuum test to check the tightness of the pneumatic circuit.	
18x	Chamber filters clogged. Remove and clean the chamber filters. See error "13x to 16x" above.	Repeat the cycle.
	HEPA filter clogged. Check and replace if necessary.	If the problem persists, call service.
2xx	Switch the sterilizer OFF and ON.	Repeat the cycle.
	Wait for the chamber to cool down. Reset the safety thermostat (see "Extraordinary maintenance" on page 75).	If the problem persists, call service.

Code	Description	Actions
3xx	Check the door gasket. Clean or replace it if necessary.	Repeat the cycle.
	Clean the chamber face side.	If the problem persists, call service.
	Check the load does not exceed the MAXIMUM WEIGHT LIMITS.	
4xx	Clean water error (bad quality, clean tank low level, high consumption of water).	Repeat the cycle.
	Drain and/or refill the clean water tank.	If the problem persists, call service.
	Check the door gasket. Clean or replace it if necessary.	
5xx	Check if there are hurdles on the door locking area (chamber rack, loads, objects, ...).	Repeat the cycle.
	Check the door gasket (wrong placed).	If the problem persists, call service.
	Check if the door can move freely without touching the trays or the load when closing.	
	Switch the sterilizer OFF and ON.	
990	The cycle has been aborted by the user.	Re-process the load.

MESSAGES AND ALERTS

Notice: For any error not listed in this table, call technical service.

Message/Alert	Description	Action
Fill clean water tank.	There is not enough water in the tank to perform a cycle.	Fill the water tank as requested.
Drain used water tank.	The used water tank is full.	Drain the water tank as requested.
Please close the door.	The door must be locked, but you didn't close it.	Close the door so it can be locked.
Non-conform water	The clean water quality is bad (conductivity between 15 and 50 $\mu\text{S}/\text{cm}$).	You may run a cycle but the water must be replaced soon, otherwise the unit will automatically lock-out to prevent damage.
Poor water quality detected. Replace with higher quality water, or equipment damage may occur.	The clean water quality is very bad (conductivity more than 50 $\mu\text{S}/\text{cm}$).	Running a cycle is inhibited to prevent damage. Replace the clean water.
Door Gasket must be replaced in ... cycles. Do you want to replace it now?	These are pre-alerts advising that one of the consumables has to be replaced within a small number of cycles.	Tap <input checked="" type="checkbox"/> if you have the consumable available for replacement. Tap <input type="checkbox"/> if you don't have the consumable in stock and must order one. In this case, the pre-alert will appear again after some cycles. See "Maintenance" on page 64.
HEPA Filter must be replaced in ... cycles. Do you want to replace it now?		

Message/Alert	Description	Action
Door Gasket replacement is due. Do you want to replace it now?	These messages advise that one consumable must be replaced.	Replace the consumable and tap <input checked="" type="checkbox"/> to reset the counter [See "Maintenance" on page 64]. If you don't replace the consumable, press <input type="checkbox"/> . In this case, you may still use the sterilizer but the message will appear again after some cycles.  CAUTION! Operating the sterilizer with expired consumables could be dangerous and could damage the sterilizer.
Have you replaced the door gasket? Press YES to reset the counter.		
Have you replaced the HEPA filter? Press YES to reset the counter.		
HEPA Filter replacement is due. Do you want to replace it now?		
Possible leak detected. Please run Vacuum Test.	Air was detected in the chamber: a vacuum leak is suspected. The cycle was completed but a vacuum test is required.	Run a vacuum test. Call for service if an anomaly is detected.
Please check: - Not to overload the sterilizer - The door gasket If the problem persists contact the service.	This message advises you that the pressure inside the chamber did not drop as expected in the first 30 seconds of drying phase.	Check the door gasket correct positioning and make sure don't overload the sterilizer chamber. If the problem persists, contact your Technical Service.

Troubleshooting

MANAGING ERRORS

If during a sterilization cycle an error occurs do the following:

- 1 Wait until the **OPEN** button appears.
- 2 At the end of the reset phase, you may open the door. A pop appears requiring a confirmation.
- 3 Tap  to open the door.



CAUTION! Do not switch off the sterilizer during the reset phase: it takes some minutes to reset the system and reach safe conditions in the sterilizer chamber.

Notice: Water could be present in the chamber when opening the door: prevent spilling (e.g., place a towel below the chamber door).

VIEW AND SAVE THE ERROR LOG

- 1 Tap  to save the list in the USB pen drive.

ERROR PAGE

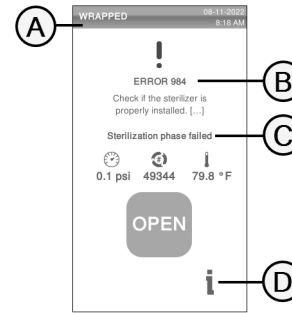

During the sterilization cycle, the sterilizer is continuously monitored by a control system. If an anomaly is detected, the cycle is aborted automatically, and the sterilizer starts a reset phase.

The following page appears:



Part	Description
A	Current sterilization cycle
B	Error number, See "Errors" on page ??.
C	Warning messages.
D	Open button that appears after the reset phase had finished.

WARNING MESSAGES

Message	Description
Load not sterile	The load is not sterile.  WARNING! Do not use items on patients!
Drying interrupted	The load might be wet.  WARNING! Wet items are for immediate use only!

RESET THE SAFETY THERMOSTAT

The sterilizer is fitted with a safety thermostat to prevent it from overheating. If the safety thermostat operates because of too high temperatures, the error 240 or a timeout error is displayed. The thermostat must be reset manually. Proceed as follows:

- 1 Switch the sterilizer OFF and remove the mains cable.
- 2 Wait for the sterilizer to cool down.
- 3 Open the sterilizer door.
- 4 Unscrew the cap and push on the reset button of the thermostat switch; a click sound indicates that the thermostat switch has been reset.
- 5 Screw the cap.
- 6 Connect the mains cable and switch the sterilizer ON.
Note: If the thermostat operates repeatedly, call technical service.
- 7 Wait for the sterilizer to finish the error reset phase and follow the instructions on the display.

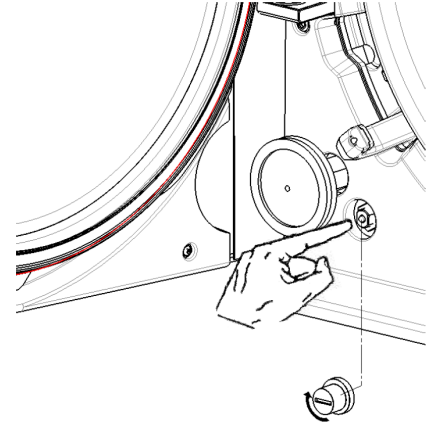

TROUBLESHOOTING TABLE

Note: If your problem is not resolved, call your authorized service provider.

Notice: Before sending the sterilizer for technical service, remove the mains cable, empty both water tanks and use the original or appropriate packaging.

Problem	Possible cause	Solutions
The sterilizer remains switched OFF.	The mains switch or network circuit breaker is OFF.	Activate the mains switch or network circuit breaker (ON).
	No voltage at the socket.	Check the electric circuit.
	The power cord is not connected properly.	Check and connect the power cord properly.
Water is leaking at the front of the sterilizer.	Leaks through the chamber door gasket.	Clean or replace the door gasket. Clean the chamber face side.
	Internal leak.	Call technical service.
The cycle commences but there is no pressure/temperature rise.	The safety thermostat switch is open.	Reset the safety thermostat switch. See "Extraordinary maintenance" on page 75
	Electric - electronic fault.	Call technical service.
At the end of the cycle, there is residual water in the chamber.	Sterilizer not properly leveled.	Properly level the surface the sterilizer is placed on.
	Overloaded chamber.	Comply with the maximum load weight limits for each type of load. Always use the chamber rack for trays and cassettes. See "Load maintenance and preparation" on page 49
	Chamber filters clogged.	Remove and clean the chamber filters.
	One or more chamber filter caps not well-positioned.	Mount the chamber filter caps properly (see "User maintenance" on page 64).
	Load incorrectly placed.	See "Load maintenance and preparation" on page 49

Problem	Possible cause	Solutions
Corrosion or spots on instruments.	Tap water on instruments when placed in the sterilizer.	Ensure that instruments are dry before they are placed in the sterilizer.
	Use of water of poor quality or water containing chemical substances.	Drain both water tanks. Use water of good quality. See "Water quality" on page 100.
	Organic or chemical residues on the instruments.	Clean, rinse and dry instruments before placing them in the sterilizer. See "Load maintenance and preparation" on page 49
	Chamber, trays, chamber rack dirty.	Clean the chamber and wash the chamber furniture.
	Contact between instruments of different materials.	Ensure that instruments of different materials do not touch (aluminium, carbon or stainless steel, etc.); place them on different trays or cassettes or pouch them. See "Load maintenance and preparation" on page 49
	Scale deposits on the chamber.	Clean the chamber and use water of good quality. See "Water quality" on page 100
Instruments are turning brown or black.	Incorrect temperature selected.	Select a sterilization cycle featuring a lower sterilization temperature. Follow the instructions of the instrument manufacturer.
The cycle report printer does not work.	Printer not properly connected or not powered.	Check the data and the power connection to the printer.
No cycles are stored in the cycle history menu.	An electronic board was replaced by service.	None. The memory of the old board cannot be restored. Save periodically the history on the USB pen drive and on another safe support.
When starting a cycle, the chamber door locks but re-opens immediately. The "Open the door" message appears.	Door gasket not properly placed; seal sticking out.	Ensure that the door gasket is evenly inserted on the entire circumference.
	Door jammed by external objects or by the load itself.	Remove any objects interfering with the chamber door. Check the door does not force against the load or the chamber furniture.

Problem	Possible cause	Solutions
When the sterilizer is connected to an automated water supply system: there is no clean water in the tank, but the automatic water filling does not fill the water.	Water fill system not connected.	Connect the water fill system to the sterilizer. See "Water quality" on page 100
	When the water fill system attempted to fill the tank, water was temporarily unavailable.	Since water tank filling is attempted only once in-between cycle execution, this event inhibits water feeding. Switch the sterilizer OFF and then ON again. Check the external water supply system. Check for water leaks from the sterilizer.
	Faulty MIN water level sensor in the clean water tank.	Call service.
The sterilizer enters the standby mode immediately after opening the chamber door.	The chamber door has not been opened after the previous cycle had finished and the standby mode delay has expired.	Press the standby button to exit.
At the end of the cycle the display reads "Open the door" but opening the door is impossible.	The HEPA filter is clogged.	See ""Emergency door opening" on the next page". Call technical service if the problem persists. Remove the HEPA filter to get the pressure released. Replace the filter. Note: The HEPA filters need to be replaced every 400 cycles.
The sterilization process phase of a sterilization cycle was longer than expected.	The chamber temperature dropped below the minimum threshold and the software performed a successful recovery.	Wait for cycle completion. If the problem occurs frequently, call technical service.
Warning about USB saving (HTML and SCL files).	The USB pen drive is not connected or not properly connected to the sterilizer.	Check presence and connection of the USB pen drive. If the problem persist, call service.
Warning about programmed maintenance.	A component shall be replaced for the programmed maintenance of the sterilizer.	Call service to order the requested component (door gasket, HEPA filter...). See "User maintenance" on page 64

Emergency door opening

WARNING ABOUT OPENING THE DOOR IN EMERGENCY



WARNING! High pressure. Risk of explosion, jet of hot steam, sudden opening of the door. Carry out the following procedure only if necessary and only when **NO RESIDUAL PRESSURE IS IN THE CHAMBER**. Any attempt to open the door while the unit is still hot or under pressure could expose the operator and the surrounding personnel to serious risk.



CAUTION! High temperature. Risk of burns. Carry out the following procedure only when the sterilizer has completely cooled down. The sterilizer should be unplugged from the mains power supply for at least 3 hours before executing this procedure.

Notice: Carry out this procedure only as indicated and with the sterilizer in the indicated conditions. Any attempt to open the door in a different way can seriously damage the sterilizer.

OPENING TOOL

The door locking system is electrically activated. In case the door remains locked due to a black-out or an electric fault, an auxiliary unlocking procedure is available.

OPEN THE DOOR IN EMERGENCY

- 1 Unplug the sterilizer and wait at least three hours.



3 h

- 2** Remove the power connection (back side).
- 3** Release the chamber pressure through the ring of the safety valve (sterilizer rear side) or wait three hours until the pressure has naturally decreased to the environment pressure.

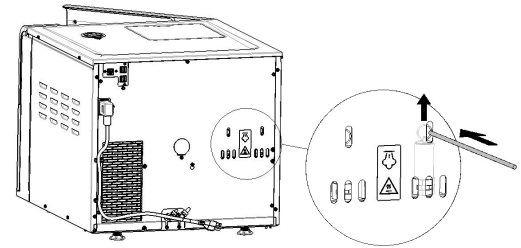

- 4** Extract the opening tool placed behind the service door.
- 5** Remove the cap.

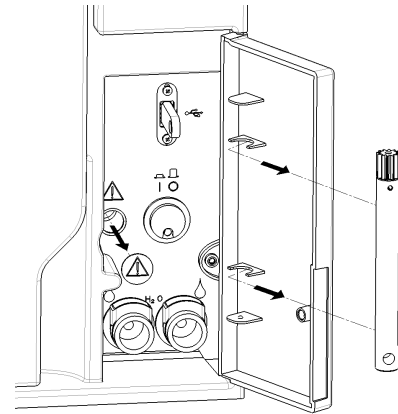

- 6 Insert the opening tool into the hole and then turn it counterclockwise until the door is unlocked (proceed slowly until it stops).

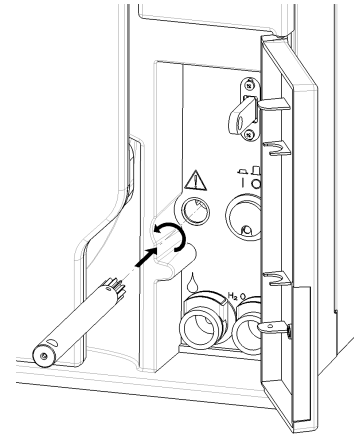

Technical data

CONTENTS

This section deals with the following subjects:

Sterilization programs	90
Sterilization cycle phases	93
Technical data	97
Recommendations for validation	98
Diagrams	99
Water quality	100
Accessories, spare parts, consumables	102
Authorized W&H service partners	104

Sterilization programs

WARNINGS



WARNING! For your safety and for the safety of your patients:

Never process objects different from those specified in the cycle program table and never exceed the maximum load weight limits specified in it. Such actions could result in non-sterile conditions at the end of the cycle, could expose people to the hazard of cross-infections, are considered as an improper use of the sterilizer for which the manufacturer cannot be hold responsible.

An improper use of these profiles will result in wet load at the end of the cycle, exposing the load to a contamination due to improper storage.

The display reminds the maximum permitted load before starting a cycle. All indications of sterile load or successful completion of the cycle that are given on the display at the end of the cycle are not valid if the type and quantity of the load are not complied with.

STANDARD STERILIZATION PROGRAMS

The sterilizer offers three preset FDA cleared sterilization programs that comply with the American National Standard ANSI/AAMI ST55.

CUSTOM STERILIZATION PROGRAMS

 **WARNING! The custom programs are not FDA cleared and it is the responsibility of the user to validate these programs.**

The sterilizer provides the following custom programs. These programs are disabled by default.

Program	Sterilization Temperature	Sterilization Time [settable]	Drying time [settable]
Custom A ¹	250 °F (121 °C)	15–60 minutes	30–60 minutes
Custom B ¹	270 °F (132 °C)	4–30 minutes	3–60 minutes
Custom C ¹	273 °F (134 °C)	3–30 minutes	3–60 minutes

¹: This is a profile defined by ANSI/AAMI ST55 as a dynamic-air-removal (steam-flush pressure-pulse). This profile can be enabled by the user. Some of the parameters can be adjusted by the user according to his needs (Plateau/Sterilization phase, dry time, ecc...). The cycle is not FDA cleared. .

STERILIZATION PROGRAM OPTIONS

 **WARNING! The sterility of items processed unwrapped is compromised on exposure to non-sterile environments. Ensure that items are dry when removed from the sterilizer. If the default drying time is not adequate for the load to be sterilized, additional drying time can be added (see "Set the sterilization cycle start" on page 55). To load properly the sterilizer see "Prepare the sterilizer" on page 52.**

	Sterilization cycles							
	Wrapped			Low Temperature			Unwrapped ¹	
Sterilization temperature	270 °F (132 °C)			250 °F (121 °C)			270 °F (132 °C)	
Sterilization program type according ANSI/AAMI ST55	Dynamic-air-removal: Pre-vacuum			Gravity displacement			Dynamic-air-removal: Pre-vacuum	
Sterilization program type according EN 13060	Class B			Class B			Class S	
Sterilization time (minutes)	4'			30'			4'	
Drying time (minutes)	Range: 5' – 22' Recommended: 22'			Range: 5' – 28' Recommended: 28'			Range: 0' – 4' Recommended: 4'	
Total program duration (min) ² <i>Full loaded including drying time</i>	Empty: 28'	Full: 62'	Typical: 39'	Empty: 68'	Full: 107'	Typical: 85'	Empty: 20'	Typical: 24'
Load type	All types of load *			All types of load except handpieces *			All types of load except porous/textile *	
Maximum load weight	Pouched/unwrapped items on trays: 14 lbs (6.3 kg) ³ Items in wrapped/unwrapped cassettes or in trays and wrapped/unwrapped cassettes: 16.5 lbs (7.5 kg) ⁴ Pouched/unwrapped textile load on trays: 4.4 lbs (2.0 kg) ³			Pouched/unwrapped items on trays: 14 lbs (6.3 kg) ³ Items in wrapped/unwrapped cassettes or in trays and wrapped/unwrapped cassettes: 16.5 lbs (7.5 kg) ⁴ Pouched/unwrapped textile load on trays: 4.4 lbs (2.0 kg) ³			Unwrapped items: 18 lb (8.1 kg) ³	

*: the liquids are excluded.

1: the instruments sterilized with this cycle cannot be stored: they must be used immediately after being sterilized.

2: the total cycle time may vary depending on the type of load (solid or porous), the load weight, the duration of the drying phase (if the ECO DRY plus mode is disabled) and other factors. Values and cycle names could be different depending on country requirement.

3: the weight of trays is excluded.

4: the weight of trays and cassettes is included.

Sterilization cycle phases

COMMON LEGEND OF THE STERILIZATION CYCLE PHASES

Following is the description of the sterilization phases.

Code	Description
PHE	Pre-heating of the sterilizer. This phase is not considered a part of the cycle.
PV1 - PV3 PV1 - PV6	Vacuum pulse (removal of air from the sterilizer chamber/load).
PP1 - PP2 PP1 - PP5	Pressure pulse (steam generation).
PPH	Rise to the Plateau/Sterilization phase.
PR	Process (Plateau/Sterilization phase).
DRY	Vacuum drying.
SEP	Short phase to clean the circuit from used water.
LEV	Leveling. Pressure inside the sterilization chamber is leveled to the atmospheric pressure.
END	End of the cycle.

TYPE B STERILIZATION CYCLE PHASES

The type B sterilization cycles feature different pressure profile, duration and temperature of the sterilization phase as shown in the graphs below.

P chamber

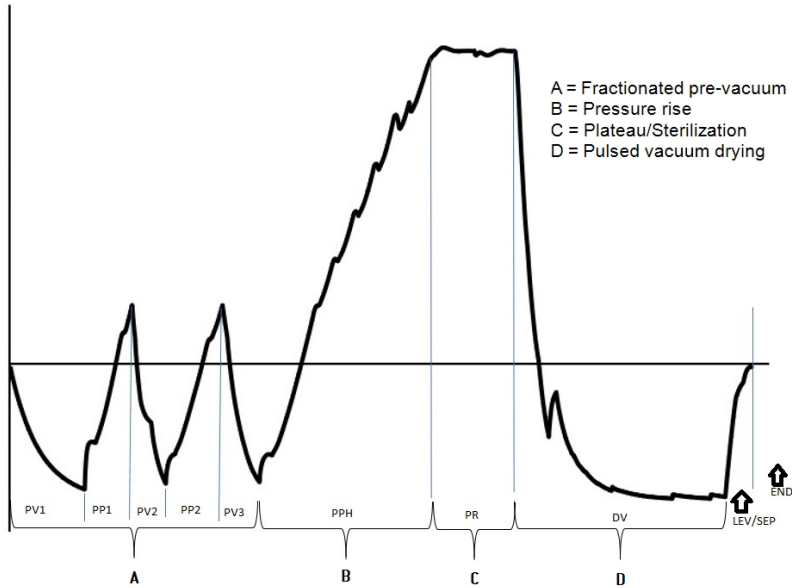

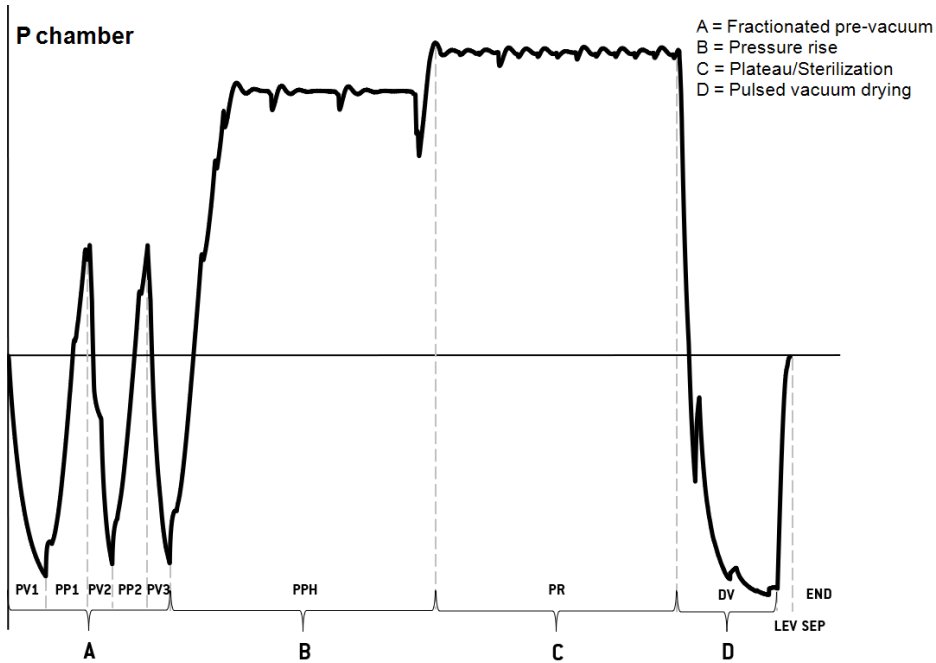

TYPE S STERILIZATION CYCLE PHASES

The S cycle is specifically designed to sterilize unwrapped instruments, for immediate use on patients, not requiring a complete drying. Thus, the drying phase of this cycle is short, making this cycle the fastest available.

P chamber

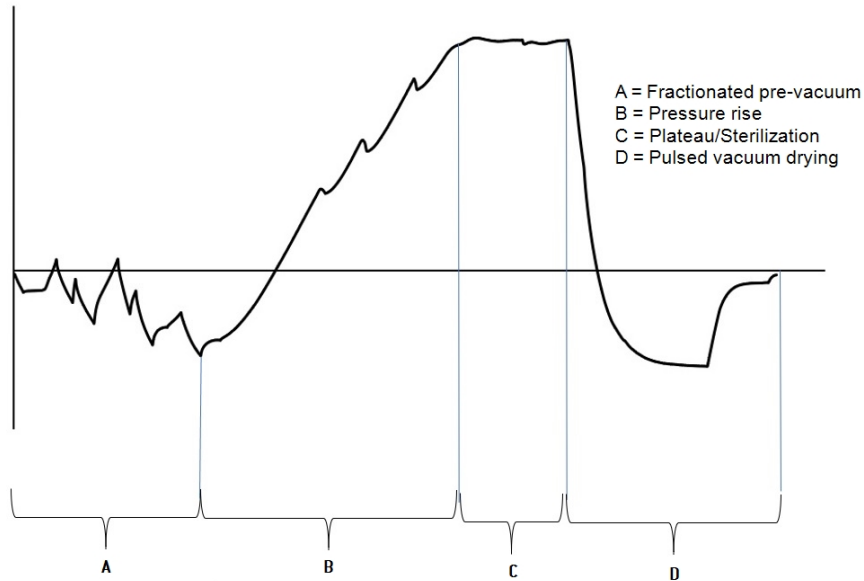

Technical data

WATER SUPPLY SYSTEM

Temperature	max. 95 °F [35 °C]
Pressure	min. 29 psi - max. 124.7 psi (min. 2 bar – max. 8.6 bar)
Flow	min. 0.066 - max. 0.132 gal/min (min. 0.25 – max. 0.5 l/min)

POWER SUPPLY SYSTEM

Nominal voltage and Max. current	200–240 V ac (±10%), 50/60 Hz, 10 A, single-phase
Overvoltage category	II
Protection required	Suitable circuit breaker and a Ground Fault Circuit Interrupter (GFCI). All protection devices must be certified according to applicable standard. A grounded connection is essential.
Communication with other devices	1 USB port in the front 4 USB ports - 1 LAN port in the rear
Features	Fully micro-processor controlled, process evaluation system according to EN13060. Programmable standby mode.
Max. heat output	3000 kJ/h

INSTALLATION REQUIREMENTS

Working temperature	From +41 °F to +104 °F (from +5 °C to +40 °C)
Working relative humidity	Max. RH 80% up to 88 °F [31 °C], linearly decreasing to 50% at 104 °F [40 °C]

Storage temperature / rel. humidity	From -4 °F to +140 °F (from -20 °C to +60 °C) / 0–90 % (with empty tanks)
Max altitude	3000 m asl
Min. atmospheric pressure	8.7 psi [0.6 bar]
Overall dimensions	W: 19.3"/H: 17.9"/D: 24.4" (W: 49 cm/H: 46 cm/D: 62 cm)
Min. space required (feet in forward position)	W: 22.4"/H: 18.6"/D: 20.3" (W: 57 cm/H: 47 cm/D: 52 cm)
Size of the door movement	W: 21.5"/H: 16.4"/D: 15.6" (W: 55 cm/H: 42 cm/D: 38 cm)
Weight empty	119 lbs [54 kg]
Max. weight (fully loaded)	157.6 lbs [71.5 kg]
Weight per support area	42 kN/m ²
Environment pollution	Degree 2
Usage environment	Indoor

STERILIZER CHAMBER

Pressure safety valve	37.7 psi [2.6 bar]
Safety thermostats	356 °F [180 °C]
Total volume	~7.4 gal, Ø: 11"/D: 18" ~28 l, Ø: 279.5 mm/D: 456.8 mm
Usable space *	W: 9.05"/H: 9.05"/D: 15.35" (W: 230 mm/H: 230 mm/D: 390 mm)
HEPA filter	0.3 µm

STEAM GENERATOR

Pressure safety valve	72.51 psi [5 bar]
Safety thermostats	446 °F [230 °C]

DISTILLED OR DEMINERALIZED WATER



Water quality	See the Test instructions service book (conductivity : < 10µS/cm, Total Dissolved Solids: < 6.5 ppm)
Average water consumption	0.07 to 0.23 gal/cycle (0.26 to 0.85 litres/cycle)
Tank volume	Clean water 1.27 gal (4.8 l) Min. water charge 0.22 gal (0.82 l) Used water 1.35 gal (5.11 l)

*: usable space with standard rack and trays. With optional racks and trays, see Accessories, spare parts, consumables.

Recommendations for validation

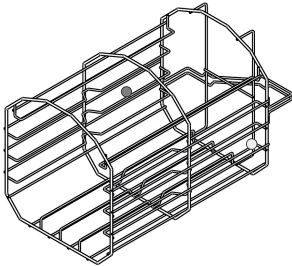
TEST VALIDATION POINTS



Part	Description
	Hottest points
	Coldest points

Diagrams

CONNECTION DIAGRAMS

Data communication

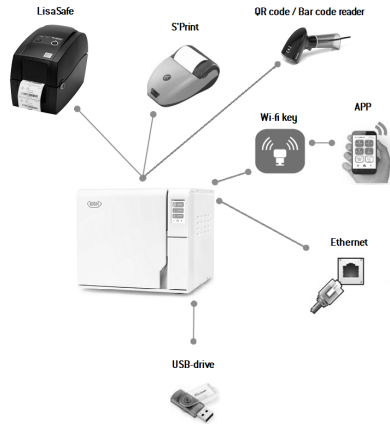

Water system

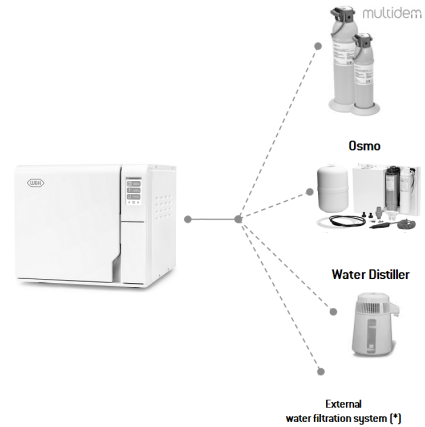

(*): for water requirements see "Water quality" on the next page.

Water quality

FEED WATER SPECIFICATIONS (ANSI/AAMI AND AAMI TIR34)

The table below lists the specifications for the water used for steam sterilization according ANSI/AAMI ST55 and AAMI TIR34. Following is the Table 1 AAMI TIR34.

	Units	Utility water ¹ flushing/ washing/ rinsing	Critical water finale rinse ² /steam
Hardness	mg/L	< 150 ³	< 1
Conductivity	µS/cm	< 500	< 10
Total Dissolved Solids	ppm	< 350	< 6.5
pH ⁴		6 – 9	5 – 7
Chlorides	mg/L	< 250	< 1
Bacteria	cfu/mL	n/a, <10 ⁵	< 10
Endotoxin	EU/mL	n/a, <20 ⁵	< 10

Note 1: This is the quality of water that might come from the tap but might need some form of treatment to achieve these specifications.

Note 2: If this is the final rinse prior to sterilization of a critical device.

Note 3: If hardness is greater than 150 mg/L, a water softener is recommended unless used for washing and the cleaning chemistry is capable of handling higher levels of hardness.

Note 4: For boiler-treated steam, most boilers are treated to maintain a pH of 7.5 or 8.5. Any treatment of water that goes into boilers should be in accordance with the sterilizer and boiler manufacturers' written IFU.

Note 5: After high-level disinfection.

Notice:

The use of water with a conductivity greater than $10\mu\text{S}/\text{cm}$ (6.5 ppm) may affect the sterilization process and damage the sterilizer.

The use of water with a conductivity greater than $50\mu\text{S}/\text{cm}$, or not complying with the specifications in the table above, may strongly affect the sterilization process and seriously damage the sterilizer.





The manufacturer's warranty is void if the sterilizer was used with water containing contaminant or chemical levels exceeding those listed in the table above.





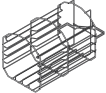
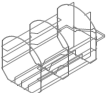

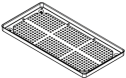



Accessories, spare parts, consumables







Note: use only accessories, spare parts and consumables recommended by W&H.



Note: before purchasing, check that the accessories fulfill all applicable standards in the country of use.

LIST OF ACCESSORIES AND SPARE PARTS

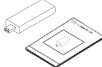

Picture	Part	Part number
	Standard chamber rack	F523037X
	<p>Optional chamber rack for 3 trays / 3 taller cassettes or 4 standard cassettes</p> <p>Usable space - Tray / Cassette size [mm]:</p> <ul style="list-style-type: none"> ■ 207 x 48 x 48 	 F523036X
	Aluminium tray (22 l)	F523205X
	Large aluminium tray	F523211X

Picture	Part	Part number
	Tray holder	F523001X
	Drain tube kit with fittings	A812110X
	Emergency door opening tool	S520009X
	Drain tube	S230903X
	Permanent drain tube (3 m)	W230009X
	Mains cable	U38012XX
	Network data cable RJ45 (3 m)	A801500X
	USB pen drive	V000004X
	Serial printer	19721108
	USB adapter for serial printer	A801503X

Picture	Part	Part number
	Label printer (label printer only)	19721109
	Label printer USB connection kit <ul style="list-style-type: none"> ■ USB connection cable ■ 1 roll of 2100 labels ■ 1 wax/resin ribbon ■ activation code instructions 	19721131
	Label printer consumable kit <ul style="list-style-type: none"> ■ 2 rolls of 2100 labels ■ 2 wax/resin ribbons 	A810513X
	Roll of thermal paper	A810504X
	QR code / Bar code reader for labels	19721132
	Multidem C27 water demineralizer	19723112
	Multidem resin cartridge	A812016X

Picture	Part	Part number
	Osmo water demineralizer (220 V)	19721134
	Wi-Fi dongle key	19721137
	Lifting strap	F602001X
	B&D test pack	T800003X

CONSUMABLES

Picture	Part	Part number	When replace it
	HEPA filter (bagged)	W322400X	Every 400 cycles
	Door gasket	F460535X	Every 1200 cycles
	Maintenance kit Components: <ul style="list-style-type: none"> ■ 1 HEPA filter ■ 1 door gasket ■ Chamber filter (set of 3 pieces) 	X050334X	-

Authorized W&H service partners

A list and a map with your nearest W&H service partner are available at www.wh.com.

Documentation forms

CONTENTS

This section deals with the following subjects:

W&H installation check-list105

W&H installation check-list

QUESTIONS

N.	Question	Answer	
Responsibility			
1	Was the head of the clinic/practice present during all the in-service?	Yes	No
Packaging and content			
2	Is the packaging of the sterilizer undamaged?	Yes	No
3	When unpacked, is the sterilizer undamaged?	Yes	No
4	Are all the contents of the package available (sterilizer ship-with)?	Yes	No
5	Are all the ordered accessories available with the sterilizer?	Yes	No
6	Have you removed all the protection covers from the sterilizer and from all the ship-with?	Yes	No

N.	Question	Answer	
Completeness of the Instructions for Use			
7	Were all sections of the Instructions for Use of the sterilizer covered and explained during the in-service?	Yes	No
Workplace suitability			
8	Is the allocated countertop for the sterilizer levelled and flat?	Yes	No
9	Are the recommended ventilation indications of the allocated area for the sterilizer respected?	Yes	No
10	Are the required minimum clearances respected?	Yes	No
11	Have you explained which water quality is required for the use of the sterilizer? Check and measure the $\mu\text{S}/\text{cm}$ of the water.	Yes	No
Involvement of the Head of the clinic/practice			
12	Have you shown the Head of the clinic/practice the procedure for filling and draining the main and used water tanks?	Yes	No
13	Have you shown the Head of the clinic/practice how to program the sterilizer?	Yes	No
14	Have you shown the Head of the clinic/practice the cycle options?	Yes	No
15	Have you shown the Head of the clinic/practice what the messages and alarms mean?	Yes	No

N.	Question	Answer	
		Yes	No
16	Have you shown the Head of the clinic/practice how to manually abort a cycle?	Yes	No
17	Have you shown the Head of the clinic/practice the maintenance program and procedures?	Yes	No
18	Have you shown the Head of the clinic/practice how to use all of the accessories?	Yes	No
19	Have you shown the Head of the clinic/practice the advantages of having a USB connection for a pen drive?	Yes	No
20	Have you shown the Head of the clinic/practice the advantages of having a LAN connection?	Yes	No
21	Have you suggested to the Head of the clinic/practice to periodically backup the data, stored on the USB pen drive and/or in a PC, on another safe support?	Yes	No
22	Have you shown the head of the clinic/practice the advantages of having a connection (remote data saving)?	Yes	No
23	Have you explained to the head of the clinic/practice the correct load type for each available sterilization program?	Yes	No
24	Have you shown the head of the clinic/practice how to prepare and place the load in the sterilizer chamber?	Yes	No
25	Have you explained to the head of the clinic/practice to use only original parts and accessories on the sterilizer?	Yes	No
26	Have you shown and explained to the head of the clinic/practice the safety advise section?	Yes	No
Check			
27	Have you executed a Vacuum test?	Yes	No

N.	Question	Answer	
		Yes	No
28	Have you executed a Wrapped/Pouched 270 °F [132 °C] with the tray rack and trays inserted?	Yes	No
29	Are all connections to the sterilizer well positioned and plugged (accessories, etc...)?	Yes	No

INSTALLATION INFORMATION

RIS-311 Serial Number:	
Date:	
Purchased from:	
Installed by:	
Dr./Clinic name:	
Address:	
Phone:	
Receiver's signature:	
Installer's signature:	

ADDRESSES FOR SENDING THE INSTALLATION CHECK-LIST

Send a copy of the installation check-list duly filled-in to both of the following addresses:

Fax:	+43 6274 6236-55
Mail	Ignaz-Glaser-Straße 53, Postfach 1 5111 Bürmoos Austria



 **W&H Sterilization Srl**

via Bolgara, 2
Brusaporto (BG)
Italy
www.wh.com
+39 035 66 63 000



RIS-311
Instructions for Use
ENG
Rev03
29/08/2022
Subject to changes